

3-10-2010

# Environmental Life Cycle Assessment of Coal-Biomass to Liquid Jet Fuel Compared to Petroleum-Derived JP-8 Jet Fuel

Wayne C. Kinsel

Follow this and additional works at: <https://scholar.afit.edu/etd>

 Part of the [Oil, Gas, and Energy Commons](#)

---

## Recommended Citation

Kinsel, Wayne C., "Environmental Life Cycle Assessment of Coal-Biomass to Liquid Jet Fuel Compared to Petroleum-Derived JP-8 Jet Fuel" (2010). *Theses and Dissertations*. 2116.  
<https://scholar.afit.edu/etd/2116>

This Thesis is brought to you for free and open access by the Student Graduate Works at AFIT Scholar. It has been accepted for inclusion in Theses and Dissertations by an authorized administrator of AFIT Scholar. For more information, please contact [richard.mansfield@afit.edu](mailto:richard.mansfield@afit.edu).



**ENVIRONMENTAL LIFE CYCLE ASSESSMENT OF COAL-BIOMASS TO  
LIQUID JET FUEL COMPARED TO PETROLEUM-DERIVED JP-8 JET FUEL**

THESIS

Wayne C. Kinsel, Captain, USAF

AFIT/GEM/ENV/10-M05

**DEPARTMENT OF THE AIR FORCE  
AIR UNIVERSITY**

**AIR FORCE INSTITUTE OF TECHNOLOGY**

**Wright-Patterson Air Force Base, Ohio**

APPROVED FOR PUBLIC RELEASE; DISTRIBUTION UNLIMITED

The views expressed in this thesis are those of the author and do not reflect the official policy or position of the United States Air Force, Department of Defense, or the United States Government.

ENVIRONMENTAL LIFE CYCLE ASSESSMENT OF COAL-BIOMASS TO LIQUID JET  
FUEL COMPARED TO PETROLEUM-DERIVED JP-8 JET FUEL

THESIS

Presented to the Faculty

Department of Systems and Engineering Management

Graduate School of Engineering and Management

Air Force Institute of Technology

Air University

Air Education and Training Command

In Partial Fulfillment of the Requirements for the  
Degree of Master of Science in Engineering Management

Wayne C. Kinsel, BS

Captain, USAF

March 2010

APPROVED FOR PUBLIC RELEASE; DISTRIBUTION UNLIMITED

ENVIRONMENTAL LIFE CYCLE ASSESSMENT OF COAL-BIOMASS TO LIQUID JET  
FUEL COMPARED TO PETROLEUM-DERIVED JP-8 JET FUEL

Wayne C. Kinsel, BS  
Captain, USAF

Approved:

- SIGNED -

1 Mar 10

\_\_\_\_\_  
Charles A. Bleckmann, Ph.D. (Chairman)

\_\_\_\_\_  
date

- SIGNED -

26 Feb 10

\_\_\_\_\_  
James T. Edwards, Ph.D. (Member)

\_\_\_\_\_  
date

- SIGNED -

1 Mar 10

\_\_\_\_\_  
Alfred E. Thal, Jr., Ph.D. (Member)

\_\_\_\_\_  
date

- SIGNED -

1 Mar 10

\_\_\_\_\_  
Peter Feng, Maj, USAF, Ph.D. (Member)

\_\_\_\_\_  
date

## Abstract

The United States (U.S.) imported 57% of the petroleum products that it consumed in 2008. The Department of Defense (DOD) and in particular, the United States Air Force (USAF), consumes a large amount of oil to support the mission of defending the U.S. According to the USAF energy policy, by 2016, the Air Force (AF) must be prepared to cost competitively acquire 50% of its domestic aviation fuel requirement via an alternative fuel blend in which the alternative component is derived from domestic sources produced in a manner that is “greener” than fuels produced from conventional petroleum. This study employed a life cycle assessment (LCA) tool known as Economic Input-Output Life Cycle Assessment (EIO-LCA) to compare the petroleum derived jet fuel of JP-8 to the alternative jet fuel of Coal-Biomass to Liquid (CBTL) to determine which was “greener” by determining the total global warming potential (GWP) over each jet fuels’ entire life cycle. The CBTL jet fuel was determined to be “greener” for the environment with utilizing carbon capture and storage (CCS) via the Fischer Tropsch (FT) synthesis process when producing liquid jet fuel from coal and switchgrass as the biomass.

*To my fiancée and my parents*

## Acknowledgments

I would like to express my sincere appreciation to my thesis advisor, Dr. Charles Bleckmann, and my sponsor, Dr. Tim Edwards, from Air Force Research Laboratory Propulsion Directorate. I also wish to thank Dr. Alfred Thal and Major Peter Feng who served on my thesis committee. Without all of your guidance and expertise this thesis would not be possible. Thank you all for guiding and mentoring me through this endeavor.

I wish to thank my fellow AFIT/GEM students. My time here at AFIT has been enjoyable because of all of you. I look forward to serving with you throughout our Air Force careers.

I am very grateful for my parents who have supported me through every challenge and accomplishment my entire life. Without your enduring love and unending support, I would not be the person I am today.

Finally, I would like to extend special thanks to my beautiful fiancée. Without your love, patience, and support this thesis would not have been possible. Thank you for understanding when my stress levels were high and always being there to encourage me to press forward with the next task at hand. Therefore, this thesis is as much as a result of your dedication as it is my own.

Wayne C. Kinsel



## Table of Contents

	Page
Abstract.....	iv
Acknowledgments.....	vi
Table of Contents.....	vii
List of Figures.....	x
List of Tables.....	xii
Acronyms.....	xiii
Chapter I: Introduction.....	1
Background.....	1
Problem Identification.....	4
Research Objective.....	6
Scope/Approach.....	7
Significance.....	7
Thesis Organization.....	8
Chapter II: Literature Review.....	10
Overview.....	10
Historical Perspectives.....	10
<i>History of Oil</i> .....	10
<i>History of Gasoline</i> .....	11
<i>History of Diesel</i> .....	12
<i>History of Aviation Fuel and Aviation Fuel Types</i> .....	12
Environmental Concerns.....	14
Greenhouse Gases (GHGs).....	14
<i>Carbon Dioxide (CO<sub>2</sub>)</i> .....	16
<i>Methane (CH<sub>4</sub>)</i> .....	17
<i>Nitrous Oxide (N<sub>2</sub>O) and Fluorinated Gases</i> .....	18
Environmental/Energy Policies/Acts Pertaining to Liquid Fuels.....	18
<i>Clean Air Act of 1970 and 1990/Energy Policy and Conversation Act of 1975</i> .....	18
<i>Alternative Fuels Motor Act 1988</i> .....	19
<i>Energy Policy Act 1992</i> .....	19
<i>The Energy Policy Act 2005</i> .....	20
<i>The Energy Independence and Security Act 2007</i> .....	20
<i>The American Recovery and Reinvestment Act 2009</i> .....	21

	Page
Executive Orders.....	23
Department of Defense Energy Initiatives.....	23
United States Air Force Energy Initiatives.....	25
Alternative Fuels Pertaining to United States Air Force Aviation Program.....	29
<i>Alternative Fuels Defined</i> .....	29
<i>Current United States Air Force Alternative Fuels Program Objective</i> .....	29
<i>Biomass Explained</i> .....	30
Biofuels.....	31
Life Cycle Assessment Overview.....	34
Why Take a Life Cycle Assessment Approach.....	35
Life Cycle Assessment Models Compared.....	37
<i>Process-Based Life Cycle Assessment</i> .....	40
<i>Economic Input-Output Life Cycle Assessment</i> .....	42
EIO-LCA Methodology Limitations and Uncertainty.....	44
Petroleum-Derived Jet Fuel (JP-8) Process.....	46
<i>Overview</i> .....	46
<i>Raw Material Extraction LCA Stage—Oil</i> .....	49
<i>Raw Material Manufacturing—Refining Oil</i> .....	52
<i>Jet Fuel Use LCA Stage Petroleum Derived (JP-8)</i> .....	56
Coal-Biomass to Liquid (CBTL) Production Process.....	57
<i>Overview</i> .....	57
<i>Raw Material Extraction LCA Stage—Coal and Biomass</i> .....	59
Coal.....	59
Biomass.....	61
<i>Raw Material Manufacturing LCA Stage—Coal and Biomass</i> .....	63
Overview.....	63
Feedstock Process and Drying.....	64
Co-Gasification of Coal and Biomass.....	65
Fischer Tropsch Synthesis.....	65
Carbon Sequestration.....	67
<i>Jet Fuel Use LCA Stage Alternatively Produced (CBTL)</i> .....	68
Chapter III: Methodology.....	63
Overview.....	69
Using the EIO-LCA Model.....	69
EIO-LCA Model Steps and Calculations.....	70
EIO-LCA Tool Applied to Comparing JP-8 and CBTL Jet Fuel.....	72
EIO-LCA Tool Applied to JP-8.....	74
<i>Raw Material Extraction LCA Stage Analysis JP-8 Jet Fuel</i> .....	75

	Page
<i>Raw Material Manufacturing LCA Stage Analysis JP-8 Jet Fuel</i> .....	76
EIO-LCA Tool Applied to CBTL.....	77
<i>Raw Material Extraction LCA Stage Analysis CBTL Jet Fuel</i> .....	78
Illinois #6 Bituminous Coal Analysis.....	78
Switchgrass (Biomass) Analysis.....	80
<i>Raw Material Manufacturing LCA Stage Analysis CBTL Jet Fuel</i> .....	81
Chapter IV: Methodology.....	78
Overview.....	85
JP-8 Jet Fuel EIO-LCA Results.....	85
<i>Raw Material Extraction LCA Stage Results JP-8 Jet Fuel</i> .....	85
<i>Raw Material Manufacturing LCA Stage Results JP-8 Jet Fuel</i> .....	87
CBTL Jet Fuel EIO-LCA Results.....	89
<i>Raw Material Extraction LCA Stage Results CBTL Jet Fuel</i> .....	89
Coal Portion Results.....	89
Switchgrass (Biomass) Portion Results.....	90
<i>Raw Material Manufacturing LCA Stage Results CBTL Jet Fuel</i> .....	91
Which Jet Fuel is “Greener”, JP-8 or CBTL?.....	93
Discussion.....	94
Overview.....	94
<i>CBTL Jet Fuel Plant Cases Explored without CCS (50% CO<sub>2</sub>eq credit for switchgrass)</i> ..	95
<i>CBTL Plant Configurations Explored with CCS (50% CO<sub>2</sub>eq credit for switchgrass)</i> .....	98
Chapter V: Conclusion.....	102
Overview.....	102
Research Objective Conclusion.....	102
Limitations and Assumptions.....	103
Significance of Research.....	105
Future Research.....	107
Appendix A: Detailed Mathematical Calculations for EIO-LCA Methodology.....	111
Bibliography.....	113
Vita.....	119

## List of Figures

	Page
Figure 1: U.S. Petroleum: Domestically Produced versus Imported .....	2
Figure 2: CO2 Emission in U.S. 2006 Correlated to U.S. Energy .....	17
Figure 3: ARRA 2009 Funds Dispersed to DOD .....	22
Figure 4: Air Force Energy Strategy.....	27
Figure 5: Air Force Energy Strategic Plan Goals, Objectives, and Metrics.....	28
Figure 6: Biomass Conversion Pathways to Jet Fuel.....	31
Figure 7: Stages of a Product Life Cycle .....	36
Figure 8: Life Cycle Assessment of a T-Shirt.....	36
Figure 9: Life Cycle Assessment (CO <sub>2</sub> Emissions) Fossil Fuels vs. Biofuels .....	37
Figure 10: Structure of a Process-Based LCA Model.....	39
Figure 11: Example of GHG Outputs Sorted by GWP Column .....	44
Figure 12: Life Cycle States in NETL Document for Petroleum-Based Fuels .....	48
Figure 13: Typical Heater/Treater Unit to Remove Water and Natural Gas from Oil.....	51
Figure 14: Typical Yields from 42-U.S. Gallon Barrel of Crude Oil .....	53
Figure 15: Typical Carbon Atoms Present in Finished Products from Crude Oil .....	54
Figure 16: Petroleum Products Boiling Range, Crude Oil Distillation Process.....	55
Figure 17: United States Estimated Coal Reserves.....	60
Figure 18: Typical Switchgrass.....	62
Figure 19: Typical CBTL Liquid Fuel Plant with Simple CCS.....	64
Figure 20: Chemical Conversion of Hydrocarbons .....	66
Figure 21: Comparing JP-8 to CBTL Jet Fuel .....	73
Figure 22: Diesel Fuel Percentages Correlated to JP-8 Jet Fuel .....	74
Figure 23: Diesel Fuel and Jet Fuel Similar on Common Distillation Tower.....	75

	Page
Figure 24: Using the EIO-LCA On-Line Tool.....	76
Figure 25: Cost of Illinois #6 Bituminous Coal (U.S. \$ per Short Ton).....	79
Figure 26: GHG Emissions of CBTL Plants Compared to the Petroleum Baseline of Conventional Diesel of 95 kg CO <sub>2</sub> eq/mmBtu, LHV.....	82
Figure 27: Typical Percentage GHGs (CO <sub>2</sub> eq) of Petroleum Derived Liquid Fuel Production .....	83
Figure 28: GHGs for \$5,005 Million "Raw Material Extraction" LCA Stage.....	86
Figure 29: GHGs for \$462 Million for "Raw Material Manufacturing" LCA Stage.....	88
Figure 30: GHGs for \$1,091 Million for "Raw Material Extraction" LCA Stage.....	90
Figure 31: GHGs for \$242 Million for Raw Material Extraction Stage (Switchgrass), CBTL Jet Fuel, EIO-LCA .....	91
Figure 32: Carbon Flows for 15% Switchgrass (Biomass) by Weight CBTL Plant.....	100
Figure 33: Comparison of Diesel Fuel Greenhouse Gas Profiles from Various "WTT" LCA Studies ...	107

## List of Tables

	Page
Table 1: Summary of Major Jet Fuel Characteristics.....	14
Table 2: 100 Year Potentials of GHGs Converted to CO <sub>2</sub> Equivalency .....	16
Table 3: Lower Heating Value (LHV) of Kerosene Based Jet Fuel .....	84
Table 4: Conversion to kg CO <sub>2</sub> eq/mmBtu, LHV (Top 10 Sectors);.....	87
Table 5: Conversion to kg CO <sub>2</sub> eq/mmBtu, LHV (Top 10 Sectors) .....	88
Table 6: Summary of Results, CBTL Plant Configuration Case 1 .....	94
Table 7: CBTL Different Cases Explored Without CCS .....	96
Table 8: 8% Switchgrass Analysis Sorted by N <sub>2</sub> O “Top10” Contributing Sectors .....	98
Table 9: 92% Coal Analysis Sorted by CH <sub>4</sub> “Top 10” Contributing Sectors .....	98
Table 10: CBTL Different Cases Explored, With Simple Carbon Capture (>91%).....	99
Table 11: CBTL Plant Configurations, Ranked Most “Green” to Least “Green” Jet Fuel.....	103
Table 12: RSP, Crude Oil Barrel Equivalence of Various CBTL Diesel Fuel Plant Configurations .....	108

## Acronyms

• ACF	American Coal Foundation
• AF	Air Force
• AFEPMP	Air Force Energy Program Policy Memorandum
• AFMA	Alternatives Fuels Motor Act
• AFRPD	Air Force Policy Directive
• AFRL	Air Force Research Laboratory
• API	American Petroleum Institute
• ARRA	American Recovery and Reinvestment Act
• ATR	Auto Thermal Reformer
• bbl	Barrel (Oil/Petroleum=42 U.S. Gallons)
• BEA	Bureau of Economic Analysis
• BPD	Barrels per Day
• C	Carbon
• CAA	Clean Air Act
• CAFE	Corporate Average Fuel Economy
• CBTL	Coal-Biomass-to-Liquid
• CCS	Carbon Capture and Storage
• CH <sub>4</sub>	Methane
• CI/LI	Corrosion Inhibitor/Lubricity Improver
• CO	Carbon Monoxide
• Co	Cobalt
• CO <sub>2</sub>	Carbon Dioxide
• DiEGME	Diethylene Glycol Monomethyl Ether
• DOD	Department of Defense
• DOE	Department of Energy
• E.O.	Executive Order
• EGME	Ethyl Glycol Monomethyl Ether
• EIA	Energy Information Administration
• EIO-LCA	Economic Input-Output Life Cycle Assessment
• EISA	Energy Independency and Security Act
• EPA	Environmental Protection Agency
• EPAct	Energy Policy Act
• EPCA	Energy Policy and Conservation Act
• F	Fluorine
• Fe	Iron
• FSII	Fuel System Icing Inhibitor
• FT	Fischer Tropsch
• FY	Fiscal Year
• gal	Gallon (3.7854 Liters)
• GHG	Greenhouse Gas
• GWP	Global Warming Potential

• H <sub>2</sub>	Hydrogen
• ISO	International Organization for Standardization
• LCA	Life Cycle Assessment
• LHV	Low Heating Value
• LPG	Liquid Petroleum Gas
• MDA	Metal Deactivator Additive
• MILCOM	Military Construction
• mmBtu	1 Million British Thermal Unit (1 Btu=1.06 Kilojoules)
• MPG	Miles per Gallon
• mt	Metric Ton (1000 Kilograms)
• N <sub>2</sub> O	Nitrous Oxide
• NAICS	North American Industry Classification System
• NCPA	National Center for Policy Analysis
• NETL	National Energy Technical Laboratory
• OTA	Office of Technology Assessment
• ppm	Parts per Million
• psia	pounds per square inch absolute
• RFS	Renewable Fuel Standard
• RSP	Required Selling Price
• S	Sulfur
• SDA	Static Dissipater Additive
• SETAC	Society for Environmental Toxicology and Chemistry
• SRM	Sustainment Restoration and Modernization
• UDRI	University of Dayton Research Institute
• U.S.	United States
• ULSD	Ultra Low Sulfur Diesel
• UNEP	United Nations Environment Programme
• USAF	United States Air Force
• WGS	Water Gas Shifter
• WTT	Well-to-Tank
• WTW	Well-to-Wheels/Wake



# ENVIRONMENTAL LIFE CYCLE ASSESSMENT OF COAL-BIOMASS TO LIQUID JET FUEL COMPARED TO PETROLEUM-DERIVED JP-8 JET FUEL

## Chapter I: Introduction

### Background

The world is dependent on fossil fuels, and in particular oil, as an energy source. Many argue there will be oil as long as someone is willing to pay someone to produce it, but many also argue demand will surpass supply and production capacity and the world's thirst for crude oil will eventually dry up the reserves. Whatever the view, there is no argument that the U.S. needs to cut or eliminate its ever increasing demand and reliance on oil, and even more importantly, foreign oil. According to the U.S. Energy Information Administration (EIA), Official Energy Statistics from the U.S. Government, "the U.S. consumed 19.5 million barrels per day (MMbd) of petroleum products during 2008 making us the world's largest petroleum consumer, but the U.S. was only third in crude oil production at 4.9 MMbd" (Energy Information Administration (a), 2008). Figure 1 shows the difference between the petroleum products the U.S. produced versus imported in 2008 in a pie graph. The security of our nation depends on reducing our dependence on foreign oil and producing domestic, alternative sources of fuels. "While experts disagree on many energy issues, most agree that the United States needs to develop renewable and sustainable energy options now to prepare for the future, and the military must take a lead role in that paradigm shift" (Boland, 2007).

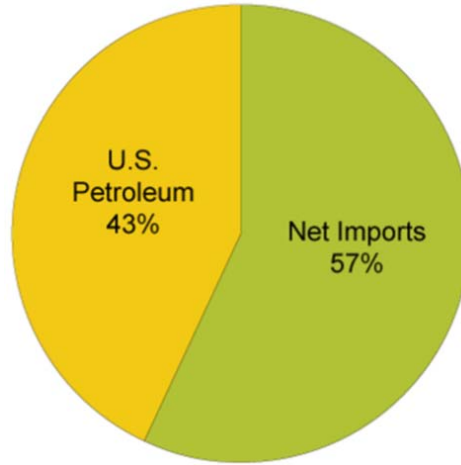

**Figure 1: U.S. Petroleum: Domestically Produced versus Imported**

(Energy Information Administration (a), 2008)

Few people worried about how long oil would continue to flow out of the ground when the oil industry was born in 1845 in Titusville, PA, but now the concern for when the world will run out of oil is greater than ever (Schoen, 2004). Oil, like other commodities is linked to the economic status of developed nations (Pirog, 2005). The price of oil is dependent on demand and the growth rates of domestic product of industrialized and developed nations. Currently, the world is in an economic down-turn and the demand and price of oil is lower than in recent years, but many experts predict the price of oil will again rise when the world recovers from the current recession. According to the EIA, total world oil consumption in the fourth quarter 2008 fell 2.8 MMbd below the fourth quarter 2007 levels, and after falling by an average of 1.8 MMbd in 2009 compared with 2008 levels, the world's oil consumption is expected to grow by 0.7 MMbd in 2010 in response to an expected positive global economic growth (Energy Information Administration (b), 2009). With the oil demand expected to grow in 2010,

the question of when the world's oil supply will run out will again become a hot topic among government leaders and oil industry experts around the globe.

Alternative, synthetically produced fuels must be developed and used domestically to reduce the U.S.'s dependence on foreign oil. The 1992 Energy Policy Act (EPAct) defined alternative fuels as pure methanol, ethanol, and other alcohols; blends of 85% or more of alcohol with gasoline; natural gas and liquid fuels produced from natural gas; propane; coal-derived liquid fuels, hydrogen; electricity; pure biodiesel (B100); fuels, other than alcohol, derived from biological materials; and P-Series fuels (United States Congress, 1992). P-Series fuels are a family of non-petroleum based fuels that are derived from such sources as biomass or the remnants remaining when natural gas is processed for transportation. Alternative fueled vehicles are any vehicle or aircraft that can operate on any of the previously defined alternative fuels. The alternative fuels currently being tested in U.S. military aviation platforms are the fuels, other than alcohol, derived from biological or biomass materials to include coal and biomass derived liquid fuels.

The alternative fuels program's current objective at the Air Force Research Laboratory's (AFRL) Propulsion Directorate and the Aeronautical System Center's Alternative Fuel Certification Office at Wright Patterson AFB, OH is to produce from biomass a "drop-in", 100% hydrocarbon jet fuel or jet fuel blendstock (Edwards, 2009). Current federal executive orders and USAF energy policies have legitimized and propelled the alternative fuels program at AFRL's Propulsion Directorate. Deciding where to obtain biomass and coal-biomass alternatively produced jet-fuels to meet the federal mandates is a significant problem for the AF and AFRL. Decision makers must

consider fuels that are cost-comparable, sustainable, capable of being produced in significant quantities, have a lifecycle greenhouse gas (GHG) footprint lower than petroleum derived jet-fuel (“greener”), and produce no degradation of flight safety (Edwards, 2009). The purpose of this thesis is to compare the alternatively produced jet fuel, Coal-Biomass to Liquid (CBTL) to the current petroleum derived jet fuel of JP-8 to determine which jet fuel is “greener” (has a lower total Global Warming Potential (GWP) due to the GHGs emitted during the fuel’s entire life cycle) for the environment.

Economic Input-Output Life Cycle Assessment (EIO-LCA), developed by economist Wassily Leontief in the 1970s, is a method to estimate the materials required for, and the environmental emissions resulting from, activities in our economy (Carnegie Mellon University Green Design Institute, 2008). This thesis compares CBTL jet fuel to JP-8 jet fuel using the EIO-LCA methodology to help answer which jet fuel is “greener” for the environment. The methods used in this thesis using the EIO-LCA tool can be expanded to compare any alternatively produced jet fuel with any petroleum derived jet fuel to determine which jet fuel is “greener” for the environment.

### **Problem Identification**

According to Executive Order (E.O.) 13423, “Strengthening Federal Environmental, Energy and Transportation Management”, any government agency operating a fleet of 20 or more motor vehicles must reduce the fleet’s total consumption 2% annually to baseline fiscal year (FY) 2005 through the end of FY 2015 and increase the total fuel consumption that is non-petroleum based by 10% annually (President George W. Bush, 2007). Fiscal year is the term the U.S. government uses to define a

financial year; the fiscal year starts 1 Oct and goes through 30 Sept of the following year. Reducing the amount of fuel consumed in petroleum based ground vehicles is a worthwhile goal and of significant concern for all federal agencies, including the USAF. However, of the \$6.9 billion the AF spent on energy costs in FY 2007, \$5.6 billion was for 2.6 billion gallons of jet fuel. The \$5.6 billion spent on jet fuel consisted of 81% of the total FY 2007 AF energy bill (Donley, 2009). Even more daunting, the AF spent \$7.7 billion in FY 2008 for 2.4 billion gallons of jet fuel. The \$7.7 billion spent on jet fuel consisted of 85% of the total FY 2008 AF energy bill (Aimone, 2009).

According to Air Force Energy Program Policy Memorandum (AFEPPM) 10-1.1 (16 June 2009), the USAF must be prepared to acquire 50% of its domestic aviation fuel requirement by FY 2016 via an alternative fuel blend in which the alternative fuel component is derived from domestic sources that are “greener” than fuels produced from conventional petroleum (Donley, 2009). The best sources of these “greener” alternative fuel blends must be decided by an Interagency Working Group that includes AFRL’s Propulsion Directorate, and using the criteria set forth in the Military Handbook, 510-1, “Aerospace Fuels Certification”, determine which of these alternative fuel blends meet specifications for use in current and future military aviation platforms. The EIO-LCA method will be used in this thesis to aid USAF leadership and AFRL researches in making an objective, educated, and environmentally sound decision on evaluating alternatively produced jet fuels. The comparison of JP-8 versus CBTL using the EIO-LCA methodology demonstrates one way of determining if alternative jet fuels are “greener” for the environment compared with the standard petroleum derived jet fuel.

## Research Objective

The purpose of this thesis was to compare the alternatively produced jet fuel of CBTL to the petroleum derived jet fuel of JP-8 performing a LCA of both the fuels using the EIO-LCA methodology. The “cradle-to-grave” LCA results of these two fuels determined which is “greener” for the environment. The comparison of these two fuels and results methodically prove which jet fuel is better for the environment by showing which jet fuel has the lowest total GWP due to the GHGs emitted during its entire life cycle. Again, any alternative jet fuel selected for use in the USAF must be cost-comparable, sustainable, produced in significant quantities, have a lifecycle greenhouse gas footprint lower than petroleum derived jet-fuel (“greener”), and create no degradation of flight safety. Each of these five criteria is important when selecting an alternative jet fuel, but this thesis focused solely on the environmental criteria.

The research objective of this thesis was to compare the alternatively produced jet fuel of CBTL and the petroleum derived jet fuel of JP-8 using the EIO-LCA methodology to determine which fuel is “greener” for the environment. The “cradle-to-grave” process of each of these fuels during their entire life cycle was researched and explained in detail. Then, costs associated with each life cycle stage in the process of developing each of these fuels were inputted into the U.S. 2002 Benchmark EIO-LCA on-line model and tool available at [www.eiolca.net](http://www.eiolca.net) (Green Design Institute, Carnegie Mellon University, 2009). The costs were developed based on the USAF’s FY 2008 JP-8, jet fuel consumption of 2.4 billion gallons for a cost of \$7.7 billion (Aimone, 2009). The total life cycle GWP based on the GHGs emitted for each jet fuel was determined by using the EIO-LCA on-line tool by summing the total GWP results for each LCA stage. The jet fuel, CBTL or

JP-8, with the lowest total amount of GWP is the fuel determined the “greenest” for the environment.

### **Scope/Approach**

This research compared the EIO-LCA environmental GHG emission results of JP-8 and CBTL to determine which jet fuel is “greener” for the environment. This thesis focused on comparing the two specific fuels discussed above, but the methodology is applicable to compare any alternatively produced jet fuel to any petroleum derived jet fuel. The thesis developed a tool for AFRL researchers and USAF leadership to methodically compare the total GWP of any alternative jet fuel to the total GWP of any petroleum derived jet fuels based on the GHGs emitted during each jet fuel’s entire life cycle to determine which jet fuel is better for the environment. Those results can be used to determine which alternative jet fuels are the best candidates for “drop-in” 100% hydrocarbon jet fuels or jet fuel blendstocks for future use in the USAF to fulfill the AF’s energy policy of 50% of its domestic jet fuel by 2016 must be produced by alternative fuel sources other than petroleum.

### **Significance**

The use of alternative jet fuels or alternative jet fuel blends by the Air Force are directed by Executive Orders, Energy Policy Acts, Department of Defense Directives, and Air Force Energy Program Policy Memorandums to help reduce the U.S.’s dependence on foreign oil and to reduce the total GWP due to the GHGs emitted into the atmosphere as a result of jet fuel use. Reducing the U.S.’s dependence on foreign oil will

enhance the security of our nation. Reducing GHGs will help improve our world's environment. The development of an EIO-LCA model aids USAF leadership and policy makers in determining what alternatively produced jet fuels should be used in current and future USAF aviation platforms that are "greener" than the current petroleum derived jet fuel of JP-8.

### **Thesis Organization**

Chapter II consists of the literature review for the historical perspectives of oil, fuel, and aviation fuels; and a detailed discussion of current environmental concerns based on Executive Orders, EPA acts, DOD Directives, and USAF energy policies. The cradle-to-grave process of producing JP-8 and CBTL is explained in detail. The current literature for the pros and cons for the environment of using biofuels to subsidize fossil fuels is discussed. Also, this chapter compares and contrasts various life-cycle assessment (LCA) methodologies and explains why the EIO-LCA methodology is the best tool to evaluate if any alternative jet fuel is "greener" than any petroleum derived jet fuel. The specific JP-8 and CBTL process and how those processes are broken down into life cycle assessment stages are also explained in Chapter II.

Chapter III describes using the EIO-LCA methodology and how the U.S. 2002 Benchmark on-line tool is used to determine if CBTL jet fuel is "greener" than JP-8. The EIO-LCA model steps and calculations are introduced in this chapter. Finally, the "amount of economic activity" for each LCA stage for each jet fuel is explained in Chapter III.



Chapter IV explains the results of the EIO-LCA methodology and discusses which fuel is more “greener” based the total GWP due to the GHGs emitted during each LCA stage for each jet fuel. A discussion on the significance of the results and which jet fuel, JP-8 or CBTL, is “greener” for the environment based on the EIO-LCA methodology is presented in this chapter.

Chapter V concludes the results of the thesis and discusses the assumptions made in this thesis and the limitations to the results using the EIO-LCA methodology. This chapter also discusses the benefits of this research and makes recommendations for future research.

## Chapter II: Literature Review

### Overview

This chapter provides the historical perspectives of oil, gasoline, diesel, and aviation fuel. It provides a discussion on environmental concerns to include GHGs, U.S. environmental policies and acts, and energy policies and acts pertaining to liquid fuels. It also provides a detailed discussion of current Executive Orders, DOD directives, and USAF initiatives pertaining to energy and alternative fuels. Next, alternative fuels pertaining to the USAF's aviation program and their characteristics are discussed in addition to a discussion on what is considered a 100% hydrocarbon jet fuel or jet fuel blendstock produced alternatively. The difference of both "conventional", process-based life cycle assessment and EIO-LCA models is presented along with a discussion on the benefits of looking at a product using life cycle analysis. Finally, the "cradle to grave" process for manufacturing both JP-8 (petroleum derived jet fuel) and CBTL (alternatively produced jet fuel from coal and biomass) is discussed in detail along with the LCA stages used to compare the two jet fuels using the EIO-LCA on-line tool.

### Historical Perspectives

#### *History of Oil*

According to the Paleontological Research Institution, the first oil well ever drilled was by Col Edwin Drake in 1859 in a small western Pennsylvania town called Titusville (Paleontological Research Institute, 2009). Although, the first oil well was drilled in 1859 oil was used thousands of years before that. In as early as 3000 B.C.,

Mesopotamians used oil for architectural adhesives, ship caulks, medicine, and roads; the Chinese refined crude oil to be used for heating homes and lamps in 2000 B.C. (Energy Information Administration (c), 2008). In the 1890s automobiles started to be mass produced creating the demand for gasoline, and by 1920 there were 9 million automobiles in the U.S. and gas stations were opening everywhere. From 1950-present oil continues to be the most used energy source in the U.S. because of the amount of automobiles in the country, and 1993 was the first year the U.S. imported more oil than it produced (Energy Information Administration (c), 2008). Dependence on foreign oil became a problem in the 1990s and continues to be a major problem for the security of our nation today. Reducing the amount of foreign and domestic oil our country uses is a major topic in the news, government, and society of the U.S. today.

### *History of Gasoline*

Petrol (gasoline) was the fuel used in the first cars at the end of the 19<sup>th</sup> century, and was considered at the time an undesirable bi-product of kerosene manufacturing. As the technology in cars changed, then so did the manufacturing of the fuel required to run them. In 1913 thermal cracking was introduced in the distillation process to convert more of petroleum into gasoline. Basically, the heating of crude oil caused the molecules to break-up and increased the proportion of volatile fractions suitable for gasoline manufacturing (Shell, 2009). The problem with thermal cracking was that it required very high pressures to manufacture the gasoline. Certain silica/alumina-based catalysts were found to accelerate the reaction rate when added to crude oil and eliminated the need to manufacture gasoline at high pressures. Catalytic cracking produced higher

gasoline yield and a better product (Shell, 2009). Until the 1970s when the environment became more of a concern for the U.S. society lead was used as an anti-knocking agent in gasoline. Unleaded and higher octane fuels were then developed from the 1970s through the 1990s as more environmentally friendly fuels. The octane levels eventually fell and currently gasoline today still is unleaded, but the octane levels are lower than previous versions of gasoline.

### ***History of Diesel***

Diesel fuel received its name from the inventor Rudolph Diesel who invented the diesel engine in 1892 and was granted a patent on his work in 1898. Diesel engines today are capable of burning a wide variety of fuels, but diesel fuel refined from crude oil is still the most widely used (Energy Information Administration (d), 2008). Diesel is a distillate refined from crude oil, in particular, distillate No. 2 is the primary source of motor diesel fuel in the United States (Energy Information Administration (d), 2008). Current U.S. Environmental Protection Agency (EPA) laws require all highway diesel fuel sold in the U.S. to be Ultra Low Sulfur Diesel (ULSD) by December 1, 2010, which is diesel fuel with no more than 15 parts per million (ppm) of sulfur content (U.S. Environmental Protection Agency, 2005).

### ***History of Aviation Fuel and Aviation Fuel Types***

Two significant gas turbine aviation engine developers were Whittle in England and Von Ohain in Germany. Whittle ended up choosing kerosene for his turbine engine and Von Ohain originally demonstrated his turbine engine with hydrogen, but ended up with a similar liquid fuel to kerosene (MIL-HDBK-510-1 (USAF), 2008). Aviation

gasoline was used in the world's first turbo-jet powered flight on 27 August 1939, but most jet engines at the end of World War II used conventional kerosene as a fuel (MIL-HDBK-510-1 (USAF), 2008). JP-4 and Jet A-1, a naphthalene/kerosene mixture fuel, emerged in the late 1940s and early 1950s by extensive research trying to balance fuel freeze point at high altitudes and the use of crude oil for availability, volatility/vapor pressure and boil-off, and entrainment losses from fuel tanks at high altitudes as well as explosive safety concerns (MIL-HDBK-510-1 (USAF), 2008). Finally, in the 1980s military aircraft using JP-4 fuel were converted to use JP-8 fuel to strive for a single fuel for the battlefield for the AF and the Army.

JP-8 is essentially Jet A-1 with four specified military additives. The first additive in JP-8 is a Fuel System Icing Inhibitor (FSII). The first FSII used was Ethylene Glycol Monomethyl Ether (EGME) consisting of 87.3% EGME and 12.7% glycerol. The glycerol is used to protect the sealants and coatings in the fuel tanks from being attacked by EGME. EGME was then replaced with Diethylene Glycol Monomethyl Ether (DiEGME), and as of 2008 is the only FSII listed in the MIL-DTL-81333F fuel procurement specification. The second additive in military JP-8 is a Static Dissipater Additive (SDA) to prevent sparks in fuel hoses, valves, or filters. The only static dissipater available is Octel's Stadius 450 additive. The third additive in JP-8 is a Corrosion Inhibitor/Lubricity Improver (CI/LI) which is basically an additive composed of fatty acids to prevent corrosion and improve lubrication in the fuel pipelines. Finally, the fourth additive in JP-8 is a Metal Deactivator Additive (MDA) to prevent fuel oxidation with trace metals such as copper or zinc that may be in the jet fuel (MIL-HDBK-510-1 (USAF), 2008).

Similarly, the Navy's aviation fuel underwent similar evolutions and now uses primarily JP-8 fuel for its aircraft at most land Naval Air Stations and JP-5 for aircraft at sea (MIL-HDBK-510-1 (USAF), 2008). Finally, Russia also evolved its aviation fuel down to TS-1 and RT jet fuels which are interchangeable with Jet A-1 and JP-8 with exception of the type of approved additives the U.S. military uses in its aviation fuels for enhanced safety (MIL-HDBK-510-1 (USAF), 2008). Table 1 below shows a summary of the different characteristics of the jet fuels in use today.

**Table 1: Summary of Major Jet Fuel Characteristics**

(MIL-HDBK-510-1 (USAF), 2008)

	<b>JP-8</b>	<b>Jet A</b>	<b>Jet A-1</b>	<b>TS-1</b>
Flash point (min), °C (°F)	38 (100)	38 (100)	38 (100)	28 (82)
Freeze Point (max), °C (°F)	-47 (-53)	-40 (-40)	-47 (-53)	n/a*
Additives	CI/LI, FSII, SDA	None	SDA	n/a**

\* Russian freeze point test method differs from other fuels, but has been found to meet the -47 °C (-53°F) spec in all cases.

\*\* Russian additives are chemically different than their Western counterparts, although they fill the same roles (icing inhibitor, static dissipater, etc.)

## Environmental Concerns

### *Greenhouse Gases (GHGs)*

GHGs are gases that trap the heat in the Earth's atmosphere. They allow sunlight to enter the atmosphere freely, but when the sun's infrared radiation that is not absorbed by the Earth's surface and re-radiated back towards space GHGs trap the heat in the

atmosphere. According to the EIA, "...if atmospheric concentrations of greenhouse gases remain relatively stable, the amount of energy sent from the sun to the Earth's surface should be about the same as the amount of energy radiated back into space, leaving the temperature of the Earth's surface roughly constant" (Energy Information Administration (d), 2009). Some GHGs occur naturally, but man-made sources tend to increase the levels of these gases in the Earth's atmosphere. Carbon-dioxide (CO<sub>2</sub>), methane (CH<sub>4</sub>), nitrous oxide (N<sub>2</sub>O), and fluorinated gases are the principle GHGs that enter the Earth's atmosphere because of human activities, primarily as the result of the combustion of fossil fuels (U.S. Environmental Protection Agency, 2008).

The international standard is to express GHGs in CO<sub>2</sub> equivalents. The other GHGs discussed above are translated into CO<sub>2</sub> equivalents using global warming potentials. According to a document published by the U.S. EPA titled, "Metrics for Expressing Greenhouse Gas Emissions: Carbon Equivalents and Carbon Dioxide Equivalents", the Intergovernmental Panel on Climate Change (IPCC) recommends using 100 year potentials. (Office of Transportation and Air Quality: U.S. EPA, 2005). The 100 year potentials are expressed in Table 2. As you can see CO<sub>2</sub> has a GWP of 1 since it is the standard to convert the other GHGs and HFC 134a is the most potent GHG with a GWP of 1,300 when equaled to CO<sub>2</sub> over a 100 year time period.

**Table 2: 100 Year Potentials of GHGs Converted to CO<sub>2</sub> Equivalency**

(Office of Transportation and Air Quality: U.S. EPA, 2005)

	GWP
Carbon dioxide (CO <sub>2</sub> )	1
Methane (CH <sub>4</sub> )	21
Nitrous oxide (N <sub>2</sub> O)	310
Hydrofluorocarbon (HFC)-134a (used in mobile source air conditioning)	1,300

*Carbon Dioxide (CO<sub>2</sub>)*

CO<sub>2</sub> is a colorless, odorless, non-flammable gas and is the most prominent GHG in the Earth's atmosphere. According to the U.S. EPA, "Carbon dioxide enters the atmosphere through the burning of fossil fuels (oil, natural gas, and coal), solid waste, trees and wood products, and also as a result of other chemical reactions (e.g., manufacture of cement). CO<sub>2</sub> is also removed from the atmosphere (or "sequestered") when it is absorbed by plants as part of the biological carbon cycle" (U.S. Environmental Protection Agency, 2008). In 2006, CO<sub>2</sub> contributed to 82% of all GHG emissions in the U.S. as a result of the combustion of fossil fuels. Figure 2 shows the U.S.'s primary energy consumption and the resulting CO<sub>2</sub> emissions.



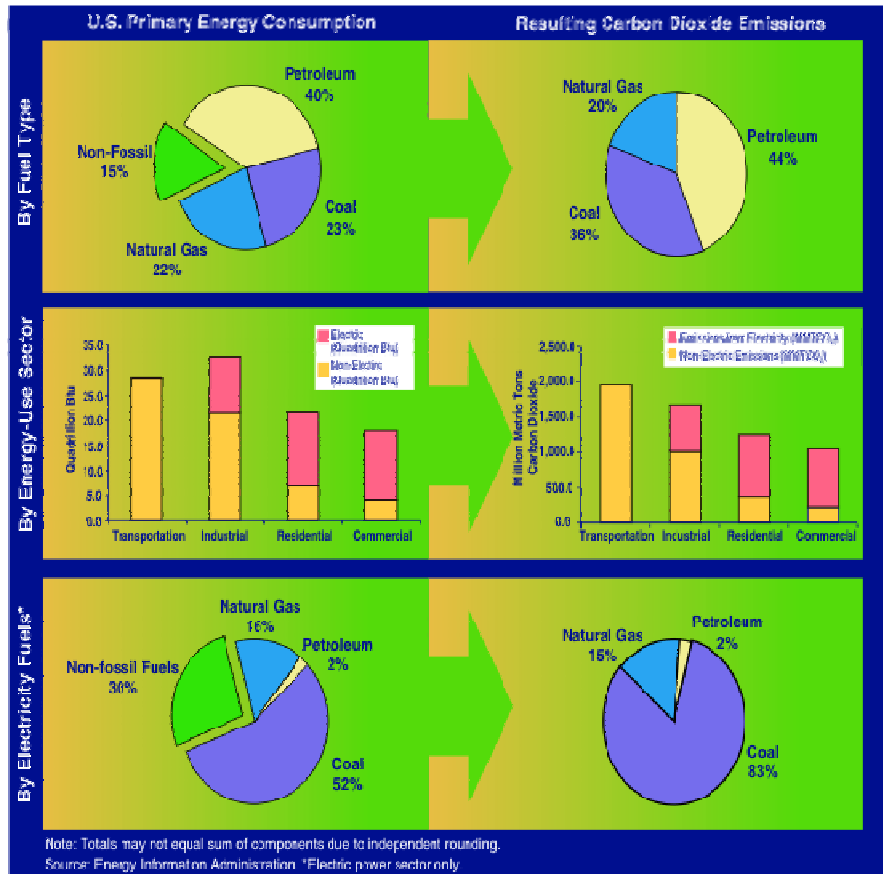

**Figure 2: CO2 Emission in U.S. 2006 Correlated to U.S. Energy**  
(Energy Information Administration (d), 2009)

### *Methane (CH<sub>4</sub>)*

CH<sub>4</sub> is a colorless, odorless, flammable gas. According to the EPA, “Methane is emitted during the production and transportation of coal, natural gas, and oil. Methane emissions also result from livestock and other agricultural practices and by the decay of organic waste in municipal solid waste landfills” (U.S. Environmental Protection Agency, 2008). CH<sub>4</sub> represented 9% of all total emissions of GHGs by the U.S. in 2006 (Energy Information Administration (d), 2009). CH<sub>4</sub> stays in the atmosphere for only 10 years, but traps double the heat as CO<sub>2</sub> (University of Michigan, 1998).

### *Nitrous Oxide (N<sub>2</sub>O) and Fluorinated Gases*

N<sub>2</sub>O is a colorless gas, but has a sweet odor. According to the EPA, “Nitrous oxide is emitted during agricultural and industrial activities, as well as during the combustion of fossil fuels and solid waste” (U.S. Environmental Protection Agency, 2008). The important part of reducing the amount of N<sub>2</sub>O released in the atmosphere is because this GHG stays in the atmosphere for roughly 100 years, which is extremely long compared with other GHGs.

Fluorinated gases, sometimes called fluorocarbons, are GHGs that are synthetically produced and contain either fluorine (F) or carbon (C). The EPA states, “Hydro-fluorocarbons, per-fluorocarbons, and sulfur hexafluoride are synthetic, powerful greenhouse gases that are emitted from a variety of industrial processes. Fluorinated gases are sometimes used as substitutes for ozone-depleting substances (i.e., CFCs, HCFCs, and halons). These gases are typically emitted in smaller quantities, but because they are potent GHGs they are sometimes referred to as High Global Warming Potential gases (“High GWP gases”)” (U.S. Environmental Protection Agency, 2008). These potent GHGs are often found in aerosol cans, air conditioners, and refrigerators.

### **Environmental/Energy Policies/Acts Pertaining to Liquid Fuels**

#### *Clean Air Act of 1970 and 1990/Energy Policy and Conversation Act of 1975*

Alternative fuel production encouragement and fuel economy legislation dates back to the Clean Air Act (CAA) of 1970 which was later amended in 1990. The CAA of 1990 created several initiatives to reduce the human and environmental exposure to multiple pollutants as a result of industry and transportation modes (Environmental

Protection Agency, 2007). Because of the Arab oil embargo and oil shortages in 1970s, Congress enacted the Energy Policy and Conservation Act (EPCA) of 1975 which created the Corporate Average Fuel Economy (CAFE) program (U.S. Department of Transportation, 2002). Under the program, automobile manufacturers in the United States were held responsible for meeting certain fuel economy standards for passenger cars and light truck fleets. The initial CAFE standard in 1978 was 18 miles per gallon (MPG) and is currently 27.5 MPG for passenger vehicles and 22.2 MPG for light trucks (trucks 8,500 pounds or less). If manufacturers do not meet these CAFE standards, then they are subject to civil penalties.

### ***Alternative Fuels Motor Act 1988***

The Alternative Fuels Motor Act (AFMA), enacted 14 October 1988, established incentives for manufacturers to receive CAFE credits for motor vehicles using alcohol or natural gas fuels, either exclusively or in conjunction with diesel and gasoline fuels. Most vehicles produced in response to the AFMA are vehicles running on E85 (85% and 15% gasoline). Electric, liquid petroleum gasoline (LPG), and bio-diesel vehicles are not covered by the 1988 AFMA (U.S. Department of Transportation, 2002).

### ***Energy Policy Act 1992***

The Energy Policy Act (EPAct) 1992 aimed to reduce the U.S.'s dependence on imported petroleum by addressing all aspects of energy supply and demand (United States Congress, 1992). This included alternative fuels, renewable energy, and energy efficiency. As stated earlier in this thesis, "The EPAct 1992 also defines "alternative fuels" as methanol, ethanol, and other alcohols; blends of 85% or more of alcohol with

gasoline (E85); natural gas and liquid fuels domestically produced from natural gas; liquefied petroleum gas; hydrogen; electricity; biodiesel (B100); coal-derived liquid fuels; fuels, other than alcohol, derived from biological or biomass materials; and P-Series fuels, which were added to the definition in 1999” (United States Department of Energy, 2009). The definition of the various forms of alternative fuels is very important when determining a sustainable, feasible alternative fuel to be used as a 100% drop-in jet fuel or jet fuel blendstock that is “greener” than the petroleum derived fuel of JP-8.

### ***The Energy Policy Act 2005***

The EPAct 2005 reinforced the EPAct 1992’s goal of reducing the U.S.’s reliance on imported oil. One of the most important changes in the 2005 act pertained to the tax incentives proposed for the production and use of alternative fueled vehicles and advanced vehicles. These tax incentives give monetary rewards to manufacturers and consumers for choosing to produce and use alternative fueled vehicles. Additionally, the EPAct 2005 amended existing EPAct 1992 regulations, including fuel economy testing procedures and previous requirements for federal and state and alternative fuel provider fleets (United States Congress, 2005).

### ***The Energy Independence and Security Act 2007***

The Energy Independence and Security Act (EISA) of 2007 aimed to improve vehicle fuel economy and again reduce the United States’ dependence on foreign oil. EISA 2007 set a Renewable Fuel Standard (RFS), which requires transportation fuel sold in the U.S. to be a minimum of 36 billion gallons of renewable fuel by 2022 including advanced and cellulosic biofuels as well as bio-mass based diesel. Also, EISA 2007

increased the CAFE standards to 35 miles per gallon for cars and light trucks by 2020. The act is projected to reduce GHG emissions in the United States by 9% by 2030 because of the energy efficient standards and provisions contained within the act.

The most important part of the EISA 2007 act that pertains to alternative fuels states, “Starting in 2016, all of the increase in the RFS target must be met with advanced biofuels, defined as cellulosic ethanol and other biofuels derived from feedstock other than corn starch —with explicit carve-outs for cellulosic biofuels and biomass-based diesel. Renewable fuels produced from new biorefineries will be required to reduce by at least 20% the life cycle GHG emissions relative to life cycle emissions from gasoline and diesel” (United States Congress, 2007). The first part definitely promotes using biomass to produce jet fuel, but if that jet fuel produced from the biomass does not have at least a 20% reduction in life cycle GHG emissions compared to the life cycle emission from petroleum derived jet fuel, then the alternative fuel does not meet the EISA 2007 standard and cannot be used as a replacement fuel.

### ***The American Recovery and Reinvestment Act 2009***

The American Recovery and Reinvestment Act (ARRA), signed by President Barack Obama on February 17, 2009 appropriates nearly \$800 billion towards the creation of jobs, economic growth, tax relief, improvements in education and healthcare, infrastructure modernization, and investments in energy dependence. The main way the 2009 ARRA supports alternative fuel and advanced vehicle technologies is through grant programs, tax credits, research and development, fleet funding, and other measures. One of the most important aspects of the act pertaining to alternative fuels is it provided

nearly \$2.5 billion to the U.S. Department of Energy (DOE) through the Office of Energy Efficiency and Renewable Energy for deployment and research projects for alternative fuel sources, including \$800 million towards biomass projects (United States Congress, 2009). Figure 3 shows the breakdown of the proposed \$7.4 billion of the ARRA which will be funneled to the DOD. All aspects of the 2009 ARRA funds awarded to the DOD will contain some sort of energy conservation, even in the Military Construction (MILCON) and Facilities Sustainment Restoration & Modernization (SRM) since the focus of those new projects will be to adhere to past and current DOD energy policies which stress energy conservation and efficiency in construction and renovation projects.

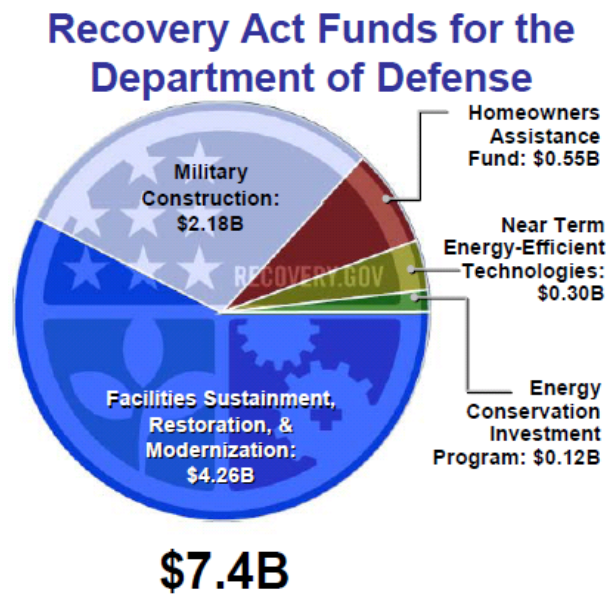

**Figure 3: ARRA 2009 Funds Dispersed to DOD**  
(United States Congress, 2009)

## **Executive Orders**

Executive Order (E.O.) 13423, Strengthening Federal Environmental, Energy, and Transportation Management, was signed on January 24, 2007 to strengthen key goals for the federal government in energy conservation. E.O. 13423 is more challenging than the goals set forth in the EPAct 2005 and superseded E.O. 13123, Greening the Government through Efficient Energy Management and E.O. 13149, Greening the Government through Federal Fleet and Transportation Efficiency. E.O. 13423 requires all Federal agencies to lead the U.S. by example by setting various goals. Here are the goals that pertain to vehicles, fuel usage, or alternative fuel vehicles and usage.

E.O. 13423 aims to increase the purchase of alternative fuel, hybrid, and plug-in hybrid vehicles when commercially available. It mandates reducing petroleum usage in government fleet vehicles by 2% annually through 2015. It requires Federal agencies to increase alternative fuel consumption at least 10% annually. E.O. 13423 mandates to reduce energy intensity by 3% annually through 2015 or by 30% by 2015, and by achieving this mandate reduce greenhouse gases. At least 50% of current renewable energy purchases must come from new renewable services (in service after January 1, 1999). E.O. 14323 consolidates and strengthens five previous executive orders and two memorandums of understanding and establishes new and updated goals to achieve energy independence and protect the environment (President George W. Bush, 2007).

## **Department of Defense Energy Initiatives**

The DOD issued several directives and instructions over the years pertaining to energy management and energy conservation. DOD directive 4170.10 implemented in

1979 titled, “Energy Conservation”, encouraged all agencies within the DOD to conserve energy and for energy conservation initiatives to coincide with any new construction project within the department. This directive was superseded by DOD Instruction 4170.10 titled, “Energy Management Policy”. This instruction mandated that all agencies within the DOD, “eliminate energy waste, improve energy utilization efficiency, and implement measures to reduce energy cost” (Department of Defense, 1991). DOD Instruction 4170.11 titled, “Installation Energy Management” implemented in 2005 replaced the DOD Instruction with the same title published in 2004. The goal of DOD Instruction 4170.11 is for the department to “strive to modernize infrastructure, increase utility and energy conservation and demand reduction, and improve energy flexibility, thereby saving taxpayer dollars and reducing emissions that contribute to air pollution and global climate change” (Department of Defense, 2005).

The Department of Defense Energy Security Task Force 2008’s draft Energy Security Strategic Plan listed four overarching goals to help the department achieve energy security. The four goals are, “1. Maintain or enhance operational effectiveness while reducing total force energy demands, 2. Increase energy strategic resilience by developing alternative/assured fuels and energy, 3. Enhance operational and business effectiveness by institutionalizing energy considerations and solutions in DOD planning & business processes, and 4. Establish and monitor Department-wide energy metrics” (DiPetto, 2008). The DOD’s energy strategic plan reiterates the need to develop and produce alternative fuels domestically as stated above in their second strategic goal.



## United States Air Force Energy Initiatives

The USAF has been a very aggressive as a DOD component in its mandatory measures to improve energy conservation and efficiency. Air Force Policy Directive (AFPD) 23-3, “Energy Management”, dated 7 September 1993 is the current governing policy within the AF regarding energy. The current AF publication regarding energy is AFEPPM, 10-1.1, dated 16 June 2009. This energy policy builds on AFPD 23-3 by establishing exact energy conservation and reduction mandates for the service as a whole. EAct 2005 and E.O. 14323, which were explained in detail earlier, established the federal energy reduction goals through FY 2015 that are mandated in AFEPPM 10-1.1 for all AF squadrons and agencies. AFEPPM 10-1.1 also explains the AF energy management strategy, goals, objectives and metrics, including all organizational relationships and existing responsibilities within the service (Donley, 2009).

The USAF’s overarching vision of the Air Force Energy Initiative is to “*Make Energy a Consideration in All We Do*”. The AF’s strategy and vision in the Air Force Energy Initiative and how they relate to the AF’s current top four priorities are displayed in Figure 4. AFEPPM 10-1.1 explains the Air Force’s Energy strategy’s three components in more detail. The first component of the strategy is *Reduce Demand* and is defined as, “Increase our energy efficiency through conservation and decreased usage, and increase individual awareness of the need to reduce our energy consumption” (Donley, 2009). The second component of the strategy is *Increase Supply* and is defined as, “By researching, testing, and certifying new technologies, including renewable, alternative, and traditional energy sources, the AF can assist in creating new domestic supply sources” (Donley, 2009). The third and final component of the strategy is *Culture*

*Change* and is defined as, “The Air Force must create a culture where all Airmen make energy a consideration in everything they do, every day” (Donley, 2009). Each of the AF Energy Strategic Plan’s three components and how they will be achieved by implementing goals, implementing objectives, and the reporting metrics are displayed in Figure 5. Implementing the component/goal of *Increase Supply* in the Air Force Energy Strategic Plan of “By 2016 be prepared to cost competitively acquire 50% of the Air Force’s domestic aviation fuel requirement via and alternative fuel blend in which the alternative component is derived from domestic sources produced in a manner that is “greener” than fuels produced from conventional petroleum” is the basis of this thesis (Donley, 2009).

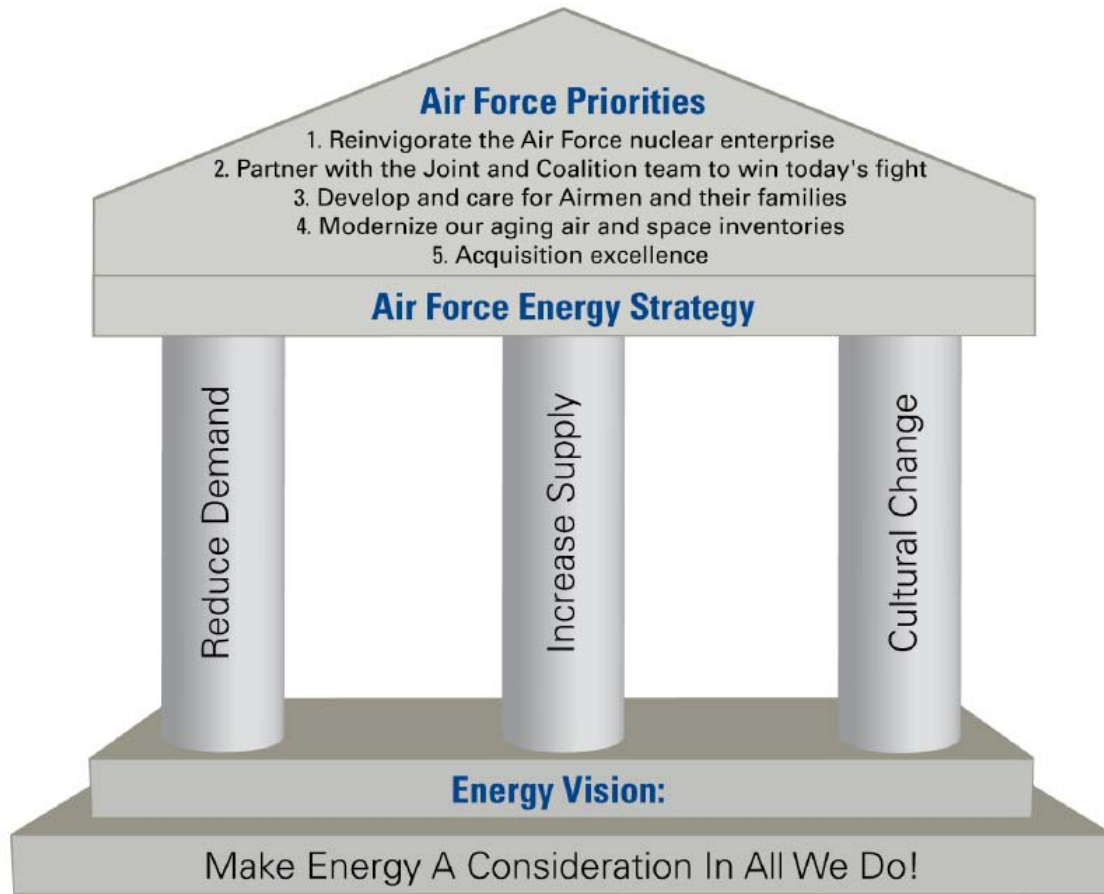

**Figure 4: Air Force Energy Strategy**

(Donley, 2009)

Air Force Energy Strategic Plan		
Goals		
Reduce Demand	Increase Supply	Culture Change
Implementing Goals		
<ul style="list-style-type: none"> <li>Reduce Aviation fuel-use/hour operation by 10% (from a 2006 baseline) by 2016</li> <li>Implement pilot fuel efficiency measures in all standardization/evaluation flights by 2010</li> <li>Incorporate pilot fuel efficiency elements in the UPT training syllabus by 2011</li> <li>Reduce motor vehicle fleet petroleum fuel use by 2% per annum</li> <li>Reduce installation energy intensity by 3% per annum</li> </ul>	<ul style="list-style-type: none"> <li>Increase non-petroleum-based fuel use by 10% per annum in the motor vehicle fleet</li> <li>Increase facility renewable energy at annual targets, 5% by FY10, 7.6% by FY13, 26% by FY25 - 50% of increase must come from new renewable sources</li> <li>By 2018 be prepared to cost competitively acquire 50% of the Air Force's domestic aviation fuel requirement via an alternative fuel blend in which the alternative component is derived from domestic sources produced in a manner that is greener than fuels produced from conventional petroleum</li> </ul>	<ul style="list-style-type: none"> <li>Provide energy leadership through the Energy Management Steering Groups</li> <li>Train all personnel in energy awareness by 2010</li> <li>Implement an energy curriculum at the Academy and the Air University by 2010</li> <li>Communicate energy awareness at all installations during Energy Awareness Month each October</li> </ul>
Objectives		
<ul style="list-style-type: none"> <li>Increase Conservation</li> <li>Improve Efficiency</li> <li>Enhance Energy Security</li> </ul>	<ul style="list-style-type: none"> <li>Increase Alternative Fuels</li> <li>Increase Renewables</li> <li>Utilize Public Private Partnership</li> <li>Enhance Energy Security</li> </ul>	<ul style="list-style-type: none"> <li>Leadership</li> <li>Training</li> <li>Education</li> <li>Communication</li> </ul>
Implementing Objectives		
<ul style="list-style-type: none"> <li>Fly Efficiently</li> <li>Develop efficient aircraft technology</li> <li>Improve jet engine performance</li> <li>Develop fuel efficient equipment</li> <li>Improve current infrastructure</li> <li>Design new buildings that are 30% better than ASHRAE standards</li> <li>Procure energy efficient products and vehicles</li> <li>Optimize utility procurement</li> <li>Evaluate lifecycle costs</li> <li>Refine the Air Force's critical asset list</li> <li>Conduct energy audits</li> <li>Implement Air Force Metering Plan by 2012 and meet annual milestones</li> </ul>	<ul style="list-style-type: none"> <li>Develop renewable resources on base</li> <li>Procure commercially produced alternative/renewable energy</li> <li>Test and certify all aircraft and systems against 50/50 alternative fuel blend by 2011</li> <li>Increase the number of flexible fuel systems</li> <li>Identify/develop privately financed/operated energy production on Air Bases</li> <li>Field the Critical Asset Prioritization Methodology (CAPM) tool</li> <li>Manage costs</li> </ul>	<ul style="list-style-type: none"> <li>Provide energy leadership throughout the Air Force</li> <li>Provide energy awareness training to each uniform and civilian member of the Air Force</li> <li>Develop energy curriculum for Air Force Academy, Air University, and other schools</li> <li>Communicate Air Force energy successes and lessons learned</li> <li>Identify/develop privately financed energy sources on underutilized land</li> </ul>
Metrics		
<ul style="list-style-type: none"> <li>Barrels of aviation fuel consumed per flight hour</li> <li>Average amount of energy consumed per building sq. ft.</li> <li>Average miles per gallon (MPG) of non-tactical ground vehicles</li> </ul>	<ul style="list-style-type: none"> <li>Percent alternative/renewable fuel used for aviation fuel requirements</li> <li>Percent alternative/renewable fuels used for installation energy requirements</li> <li>Percent alternative/renewable fuel used for non-tactical ground vehicle requirements</li> </ul>	<ul style="list-style-type: none"> <li>Energy audit score measuring compliance with Air Force energy policies and strategies</li> <li>Percentage of personnel contacted with energy awareness media</li> <li>Percentage of personnel trained in the Air Force energy curriculum</li> <li>Survey score results measuring awareness of Air Force energy policy and strategies</li> <li>Total number of Air Force personnel certified as Energy Master Black belts</li> </ul>

Figure 5: Air Force Energy Strategic Plan Goals, Objectives, and Metrics

(Donley, 2009)

## **Alternative Fuels Pertaining to United States Air Force Aviation Program**

### ***Alternative Fuels Defined***

According to the DOD Handbook, MIL-HDBK-510-1(USAF), Aerospace Fuels Certification, “The term “alternative” fuel is used to differentiate between kerosene-type jet fuel produced from crude oil and synthetic fuel produced from non-crude oil. An alternative fuel should emulate the baseline fuel’s properties to increase fungibility within military assets” (MIL-HDBK-510-1 (USAF), 2008). The current baseline, kerosene-type fuel, used by the USAF is JP-8. Any alternative fuel to be certified and used by the USAF must emulate the same exact properties of JP-8 in order to ensure no degradation of flight safety exists when flying an aircraft powered by the alternative fuel.

### ***Current United States Air Force Alternative Fuels Program Objective***

As a reminder, the objective of the USAF’s current alternative fuel program is to produce a “drop-in”, 100% hydrocarbon jet fuel or jet fuel blendstock. “Drop-in”, means the fuel is fully interchangeable with current aviation fuels in use by the USAF in performance and handling and the fuel does not produce any degradation of flight safety. Blendstock means a hydrocarbon mixture capable of being blended with current, petroleum derived aviation fuel, which is typically a 50% blend. Typically, the alternative fuel may have shortcomings in meeting all specifications for use as a military jet fuel, but when mixed as a 50-50 blend with JP-8 those shortcomings are overcome. The resulting blendstock fuel must meet jet fuel requirements specifications as laid out in MIL-DTL-83133F, Detail Specification for Kerosene Type Aviation Fuels (Edwards, 2009).

Jet fuels consist of four main classes of hydrocarbons: n-paraffins, iso-paraffins, cycloparaffins, and aromatics. Typically, the average fuel composition is 20%/40%/20%/20 %, respectively. N-paraffins, or normal paraffins, are hydrocarbons arranged in straight-chain structures that occur naturally in crude oils. Iso-paraffins are branched-chained hydrocarbons that are frequently produced during the refinement process of crude oil. Cycloparaffins, or naphthenes, are hydrocarbons where three or more carbon atoms in each molecule are united in a ring structure. Finally, aromatics are a type of hydrocarbon such as benzene or toluene that contains ring structures that include double bonds (Edwards, 2009).

### ***Biomass Explained***

There are three main types of biomass that are available to produce ground fuels and jet fuels. The first, sugars and starches, are used to make ethanol for ground vehicles. Corn is an example of a source of starch that is widely used for production of ethanol in the United States. Ethanol cannot be used for jet fuel because of its low flash point and heat of combustion. Next, fats and oils (triglycerides) are used to make biodiesel. Triglyceride is an example of a fat that is widely used to produce biodiesel. Biodiesel is used for ground vehicles, but not for jet fuel. Finally, “ligno-cellulosic” biomass is used to produce aviation fuel. “Ligno-cellulosic” biomass contains varying amounts of lignin, cellulose, and hemicelluloses. All three of these types of biomass vary in chemical structure and the differences vary the fuel processing to produce fuels from these biomasses. Figure 6, obtained from Dr. Tim Edwards at AFRL, displays the biomass conversion pathways to jet fuel. The alternative jet fuel of CBTL that this thesis is

concerned with is produced with a percentage of biomass and a percentage of coal and its conversion pathway is also shown in Figure 6 (Edwards, 2009).

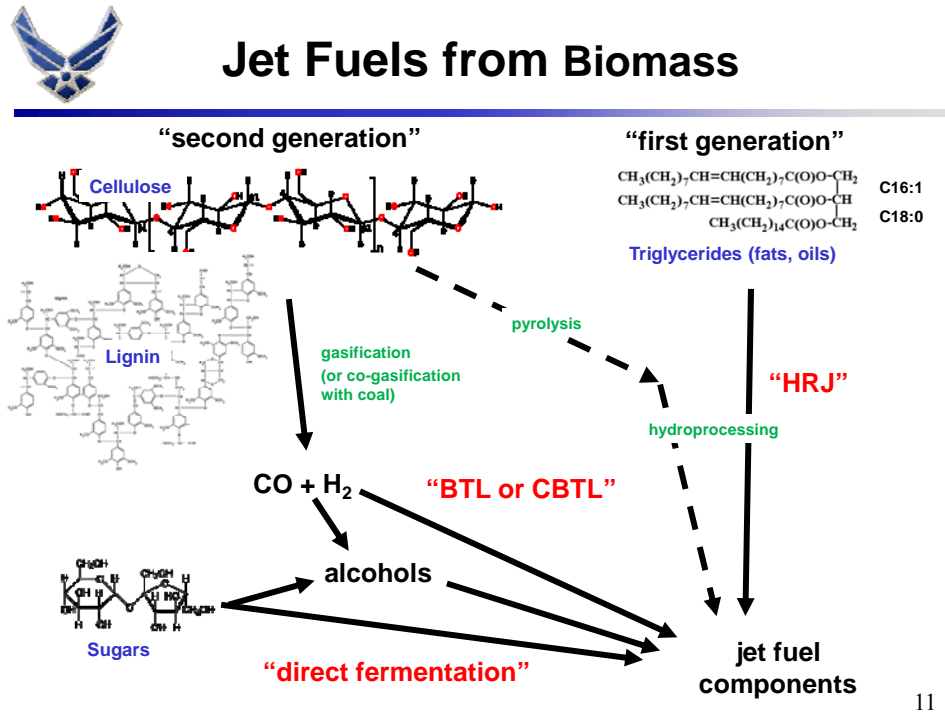

**Figure 6: Biomass Conversion Pathways to Jet Fuel**

(Edwards, 2009)

## Biofuels

Current scientific studies either state biofuels are better for the environment or biofuels are worse for the environment when comparing them with petroleum derived fuels. One of the most documented articles recently titled, “Use of U.S. Croplands for Biofuels Increases Greenhouse Gases through Emissions from Land-Use Change”, written by Princeton professor Timothy Searchinger and several colleagues in *Science Magazine* in 2008 reported that most of the previous life-cycle studies on biofuels stated

they reduced GHGs, but failed to account for the potential carbon sequestration loss due to land-use change. Searchinger et al. states, “For most biofuels, growing the feedstock requires land, so the credit represents the carbon benefit of devoting land to biofuels. Unfortunately, by excluding emissions from land-use change, most previous accountings were one-sided because they counted the carbon benefits of using land for biofuels but not the carbon costs, the carbon storage, and sequestration sacrificed by diverting land from its existing uses” (Searchinger, et al., 2008). If current forests or grasslands are converted to cropland to produce biofuel, then that conversion releases carbon previously stored in the trees and plants. According to Searchinger, “The loss of maturing forests and grasslands also foregoes ongoing carbon sequestration as plants grow each year, and this foregone sequestration is the equivalent of additional emissions” (Searchinger, et al., 2008). The authors of this well-documented peer-reviewed paper go on to state that with land-use change the payback period is significant and more GHGs emission result due to the growing and harvesting of various sources of biomass for biofuels.

On the contrary, many scientists and researchers assert producing biofuels from biomass result in a carbon credit. Most recently, Bent Sorensen an Environmental professor at Roskilde University in Denmark argues with Searchinger et al. in a letter in *Science* titled “Carbon Calculations to Consider”. Sorensen states, “T. Searchinger et al. suggests that it would be more scholarly to account for all carbon assimilation and release as function of time rather than just consider biomass carbon neutral. Some of the same authors recently attacked “second-generation” biofuels, making the prediction that biofuels will soon be derived entirely from cellulosic materials grown on marginal land” (Sorensen, 2010). The author goes on to state that more likely a lot of cellulosic



materials will come from residues from existing biomass-cultivation operations already functioning around the world. The argument is basically depending on what type of biomass (residual or grown) is obtained directly affects the amount of GHGs emitted or credited for using that biomass to produce liquid fuels.

In another article titled, “Sustainable Biofuels Redux”, Robertson et al. stated that decision makers at all levels need to ensure policies and guidelines are in place to ensure that biofuels will be a sustainable source in our renewable energy portfolio (Robertson, et al., 2008). Biofuel crops can have a negative or a positive impact on the basis of GHG emissions depending on where and how they are planted and cultivated. Robertson et al. state, “Siting cellulosic biofuel crops on marginal lands, rather than our most productive croplands, could mean preventing competition with food production and concomitant effects on commodity prices, as well as minimizing or even avoiding the carbon debt associated with land clearing” (Robertson, et al., 2008). As stated above Searchinger et al. argues that land-use change would cause biofuels to have negative impact on the carbon they emit into the environment, but according to Robertson, et al. if marginal or degraded lands are picked to plant cellulosic biofuels then a carbon credit is more likely to occur.

This thesis uses switchgrass as the biomass portion of the CBTL jet fuel compared to the petroleum derived jet fuel of JP-8. For the purpose of this thesis all of the switchgrass will be assumed to be from marginal or degraded lands and therefore does not fall into the category described by Searchinger et al. of a land-use change cellulosic biomass. Therefore, a carbon credit is assigned to the switchgrass portion of

the CBTL jet fuel analyzed in this thesis. According to a report titled, “Characterizing the Greenhouse Gas Footprints of Aviation Fuels from Fischer-Tropsch Processing”, contracted by the University of Dayton Research Institute (UDRI) to the University of Texas at Austin, Center for Energy and Environmental Resources a 50% credit on the GHGs emitted by switchgrass can be taken when performing a LCA using the biomass to produce FT jet fuels. The report states the total GHG emissions from switchgrass are 100 kg CO<sub>2</sub>eq/ton and a 50 kg CO<sub>2</sub>eq/ton credit can be taken for the usage of switchgrass. (University of Dayton Research Institute, 2010). For this thesis, 50% of the CO<sub>2</sub>eq produced by switchgrass will be subtracted when comparing CBTL to JP-8 jet fuel.

### **Life Cycle Assessment Overview**

Today’s American society is concerned with the issues of natural resource depletion and the effects of our modern lifestyles on the environment. Many businesses and institutions, including the USAF, are concerned with “greener” products and “greener” processes to help minimize their effects on the environment. A LCA is one tool to aid in this endeavor. According to the U.S. EPA, “Life cycle assessment is a “cradle-to-grave” approach for assessing industrial systems. “Cradle-to-grave” begins with the gathering of raw materials from the earth to create the product and ends at the point when all materials are returned to the earth” (Scientific Application International Corporation for United States Environmental Protection Agency, 2006). Understanding how a product or process affects the environment at each stage of its life allows for policies and decisions to be made to limit those effects.

## Why Take a Life Cycle Assessment Approach

According to the United Nations Environment Programme (UNEP) and the Society for Environmental Toxicology and Chemistry (SETAC), “Life cycle approaches help us to find ways to generate the energy we need without depleting the source of that energy and without releasing greenhouse gases that contribute to climate change” (United Nations Environment Programme, 2004). A LCA approach means we recognize our choices at each stage of a product’s life cycle: material extraction, material processing, manufacturing, use, and waste management influence each of the other stages (Figure 7). The simple example (Figure 8) of the LCA of a t-shirt explains in laymen terms what is meant by a life cycle of a given product or process.

This thesis uses the specific LCA methodology of the EIO-LCA to compare CBTL jet fuel with JP-8 jet fuel. Figure 9 shows the typical life cycle of a common jet fuel produced from fossil fuels (such as crude oil derived jet fuels) and shows the typical life cycle of an alternatively produced biofuel (such as biomass to liquid jet fuels). Theoretically, alternatively produced jet fuels produced from biomass result in reduced CO<sub>2</sub> across their entire life cycle. The CO<sub>2</sub> absorbed by the plants during the growth of biomass is approximately equivalent to the CO<sub>2</sub> released into the atmosphere when the bio-fuel is burned by a combustible engine, but biofuels are not “carbon neutral” since it takes energy for the equipment needed to grow the biomass, extract the biomass, transport the biomass, process the biomass, etc. (Air Transport Action Group, 2009). However, the net CO<sub>2</sub> released into the atmosphere by a biofuel is in theory significantly lower than the CO<sub>2</sub> released into the atmosphere by a fuel produced from petroleum or other fossil fuels. The alternative fuel, CBTL, researched in this thesis would not have

the same “carbon neutral” potential because a larger percentage of this alternative fuel is produced from the fossil fuel of coal, but in theory CBTL should impact the environment less because a certain percentage of biomass is present in the jet fuel.

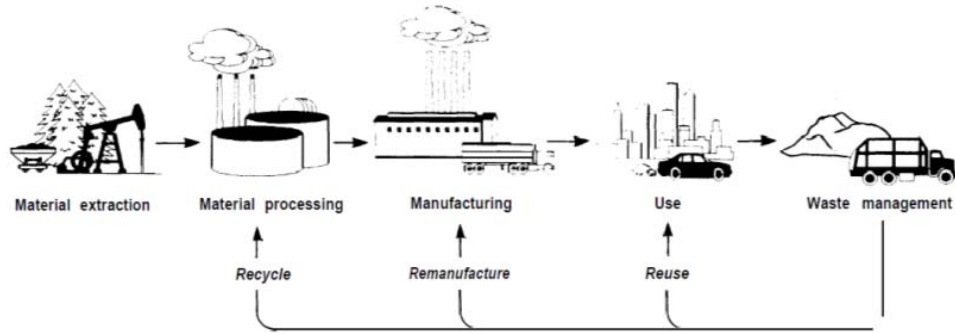

**Figure 7: Stages of a Product Life Cycle**

(Congress of the United States, Office of Technology Assessment, 1992)

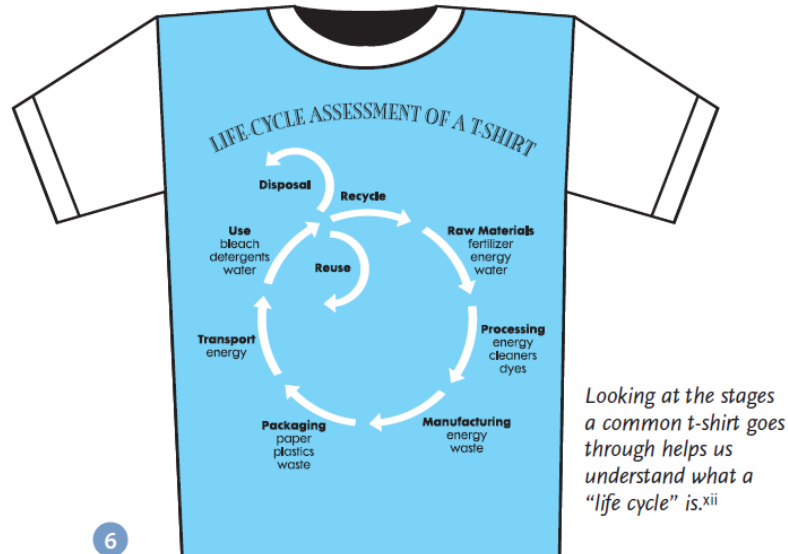

**Figure 8: Life Cycle Assessment of a T-Shirt**

(United Nations Environment Programme, 2004)

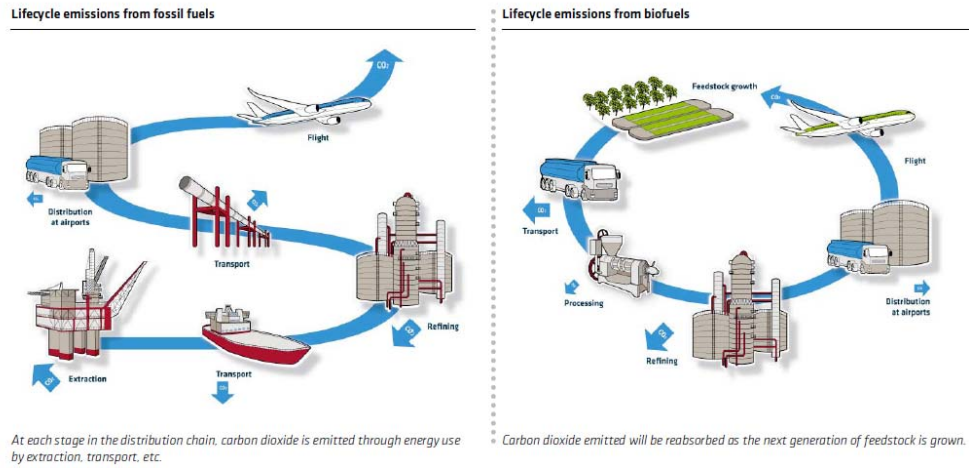

**Figure 9: Life Cycle Assessment (CO<sub>2</sub> Emissions) Fossil Fuels vs. Biofuels**  
(Air Transport Action Group, 2009)

### Life Cycle Assessment Models Compared

There are two different LCA models. The first are conventional LCA models based on process modules and process flow diagrams. The second are economic input-output (EIO) analysis LCA models based on matrices of process interactions. Both LCA models are important tools to aid in pollution prevention and green design methods for all sorts of projects (Hendrickson, Horvath, Joshi, & Lave, 1998). These LCA model tools use similar inventories of environmental emissions and resources; any increase in product output produces a corresponding environmental burden. In the case of comparing the environmental impact of the U.S. military using a petroleum derived jet fuel versus an alternatively produced jet fuel can be analyzed using either LCA model, but EIO-LCA models are more advantageous if application cost, feedback flow, or speed of analysis is important, as it is in this thesis (Hendrickson, et. al., 1998).

The International Organization for Standardization (ISO) 14000 series are international standards for environmental standards management that formalizes the various LCA models (Hendrickson, et. al., 1998). The efforts to standardize LCA models within the United States are being accomplished by SETAC and the U.S. EPA. The SETAC-EPA LCA models are the conventional models based on process modules and process flow diagrams (Figure 10). UNEP joined forces in 2002 with SETAC to launch the Life Cycle Initiative to put life cycle thinking to practice. (United Nations Environment Programme, 2004) With the partnership of ISO, SETAC and UNEP life cycle thinking is taking the forefront for businesses, government, and industries to improve their problem solving techniques in creating more sustainable ways to design and produce products.

According to Hendrickson et al., “The SETAC-EPA LCA approach focuses first on manufacturing processes (such as the manufacture of paper drinking cups), estimating fuels consumed, other resources used, and the amount of each waste discharged into the environment. The procedure then estimates the resources consumed and environmental discharges produced by the most important upstream suppliers (in the paper cup example, these would include paper mills, pulp mills, and logging operations) and downstream activities (recycling and disposal)” (Hendrickson, et. al., 1998). THE SETAC-EPA LCA process approach is typically time consuming and expensive because resource input and environmental discharge data have to be estimated for each of the processes and for each of the sub-processes included in the boundary established for the LCA of any given product.

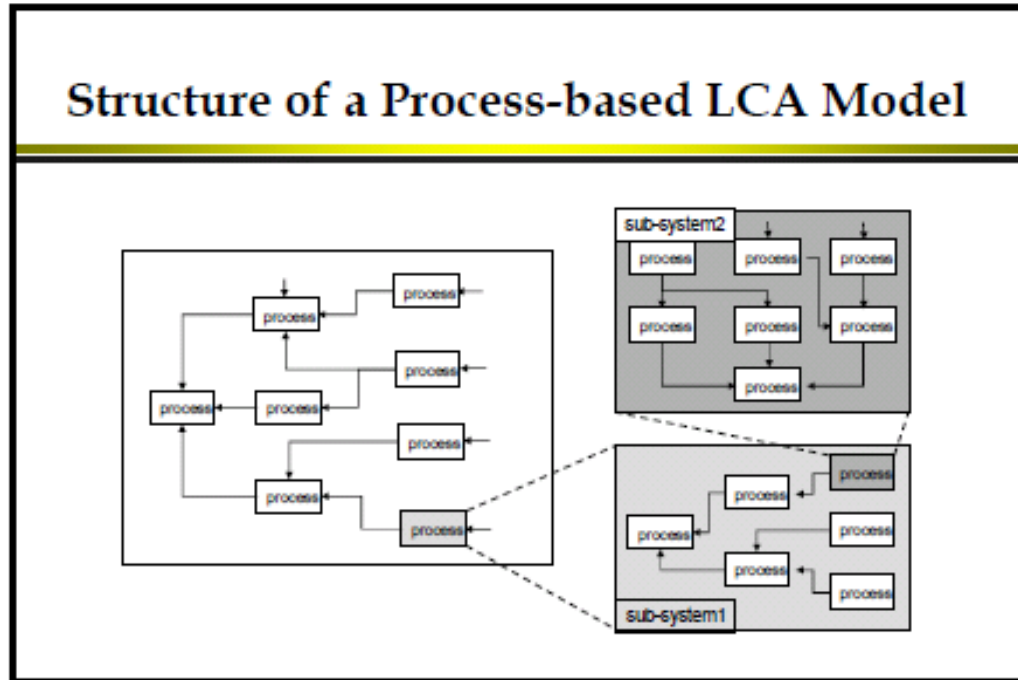

**Figure 10: Structure of a Process-Based LCA Model**

(Horvath, 2006)

EIO-LCA models in which the system boundary includes the entire economy may be the preferable alternative to traditional SETAC EPA LCA models discussed above. EIO-LCA models were developed by Wassily Leontief in the 1970s based on his earlier input-output work in the 1930s where he was awarded the Nobel Prize in economics (Carnegie Mellon University Green Design Institute, 2008). The method was operationalized in the 1990s by researchers at the Green Design Institute of Carnegie Mellon when sufficient computing power was realized for the complex matrices calculations required of the EIO-LCA model. According to Hendrickson, et al., “Leontief proposed a general equilibrium model that requires specifying the inputs that any sector of the economy needs from all other sectors to produce a unit of output. His

model is based on a simplifying assumption that increasing the output of goods and services from any sector requires a proportional increase in each input received from all other sectors. The resulting EIO matrix has presently been estimated for developed nations and many industrializing economies” (Hendrickson, et. al., 1998).

### ***Process-Based Life Cycle Assessment***

According to the “Approaches to Life Cycle Assessment” section of the EIO-LCA website,

“An initial approach to completing a life cycle assessment is a process-based LCA method. In a process-based LCA, one itemizes the inputs (materials and energy resources) and the outputs (emissions and wastes to the environment) for a given step in producing a product. So, for a simple product, such as a disposable paper drinking cup, one might list the paper and glue for the materials, as well as electricity or natural gas for operating the machinery to form the cup for the inputs, and one might list scrap paper material, waste glue, and low quality cups that become waste for the outputs.

However, for a broad life cycle perspective, this same task must be done across the entire life cycle of the materials for the cup and the use of the cup. So, one needs to identify the inputs, such as pulp, water, and dyes to make the paper, the trees and machinery to make the pulp, and the forestry practices to grow and harvest the trees. Similarly, one needs to include inputs and outputs for packaging the cup for shipment to the store, the trip to the store to purchase the cups, and that result from throwing the cup in the trash and eventually being



landfilled or incinerated. Even for a very simple product, this process-based LCA method can quickly spiral into an overwhelming number of inputs and outputs to include. Now, imagine doing this same process-based LCA for a product such as an automobile that has over 20,000 individual parts, or a process such as electricity generation” (Carnegie Mellon University Green Design Institute, 2008).

Two issues exist with process-based LCAs: 1) Defining the boundary to analyze, 2) Circularity Effects. Defining the boundary to analyze is deciding what will be included in the analysis and what will be excluded and ignored. In the paper cup example on the EIO-LCA website the following is stated, “...one might choose to exclude the impacts for making the steel and then manufacturing the processing equipment that makes the cups. Establishing the boundary limits the scope of the project and thus the time and effort needed to collect information on the inputs and outputs. While necessary to create a manageable LCA project, defining the boundary for the analysis automatically limits the results and creates an underestimate of the true life cycle impacts” (Carnegie Mellon University Green Design Institute, 2008). The other main problem of process-based LCAs is circularity effects (it takes a lot of “stuff” to make other “stuff”). To continue with the paper cup example, “...to make the paper cup requires steel machinery. But to make the steel machinery requires other machinery and tools made out of steel. And to make the steel requires machinery, yes, made out of steel. Effectively, one must have completed a life cycle assessment of all materials and processes before one can complete a life cycle assessment of any material or process” (Carnegie Mellon University Green Design Institute, 2008).

### ***Economic Input-Output Life Cycle Assessment***

The Economic Input-Output Life Cycle Assessment (EIO-LCA) model in which the system boundary includes the entire economy is the preferable alternative to a process-based LCA model for this thesis. Completing a broad and robust LCA, such as a process-based LCA requires many assumptions and decisions that make LCA a time intensive and complex process. This is where the EIO-LCA models and methodology help simplify LCA processes. The EIO-LCA model uses economic input-output matrices and industry sector level environmental and resource consumption data to assess the economy-wide environmental impacts of products and processes (Hendrickson, Horvath, Joshi, Klausner, Lave, & McMichael, 1997)

The EIO-LCA methodology helps simplify the complex nature of life cycle assessments as discussed above when describing the process-based LCA model. To accomplish this, the model uses mathematical formulas to represent the monetary transactions between industry sectors associated with each life cycle stage of a product, from the acquisition of raw materials to create the product to the end of life disposal or use of that product. EIO-LCA models indicate what goods or services (or output of an industry) are consumed by other industries (or used as input) (Green Design Institute, Carnegie Mellon University, 2008). EIO-LCA models identify the direct, the indirect, and total effects of changes to the economy. Direct effects are the first-tier transactions, the transactions between one sector and the sectors that provide it output. Indirect effects are the second-tier, third-tier, etc. transactions, the transactions among all sectors as a result of the first-tier transactions. Total effects are the sum of direct and indirect effects (Green Design Institute, Carnegie Mellon University, 2008).

Utilizing an input-output approach to conduct LCA, EIO-LCA uses economic data derived from the U.S. Bureau of Economic Analysis (BEA) and publicly available environmental data from the U.S. EPA and the U.S. DOE (Huang & Matthews, 2008). The environmental data provides data about the pollutants given off by the economic activity associated with each sector involved in the life cycle of a given product. The economic data used in the EIO-LCA on-line tool is classified into certain sectors by the Industry Census data collected by the North American Industry Classification System (NAICS). According to the NAICS website, “The North American Industry Classification System (NAICS) is the standard used by Federal statistical agencies in classifying business establishments for the purpose of collecting, analyzing, and publishing statistical data related to the United States business economy”. This thesis uses the U.S. 2002 Benchmark model which corresponds to the 2002 NAICS published codes. There are 428 industry sectors in the U.S. 2002 Benchmark tool available at the EIO-LCA website.

The environmental results displayed by the EIO-LCA on-line tool during the analysis of each stage of a products life cycle examined are displayed as results of total GWP due to the total GHGs emitted to the air by the 428 sectors (Figure 11). The results can be sorted by the largest to smallest contributing sector for each output column; Figure 11 is sorted by the column GWP. The environmental results from using the U.S. 2002 Benchmark tool from the EIO-LCA website are measured in metric tons (mt) CO<sub>2</sub>E (equivalent) and include: carbon dioxide (CO<sub>2</sub>) fossil, carbon dioxide (CO<sub>2</sub>) process, methane (CH<sub>4</sub>), nitrous oxide (N<sub>2</sub>O), and hydrofluorocarbons/perfluorocarbons (HFC/PFCs). The difference between CO<sub>2</sub> fossil, CO<sub>2</sub> process is “fossil” is the resulting

CO<sub>2</sub> into the air from each sector due to fossil fuel combustion whereas “process” is the resulting CO<sub>2</sub> into the air from each sector for everything else. The total GWP due to the GHGs emitted during each life cycle for each jet fuel will be used to determine which of the two jet fuels is “greener” for the environment.

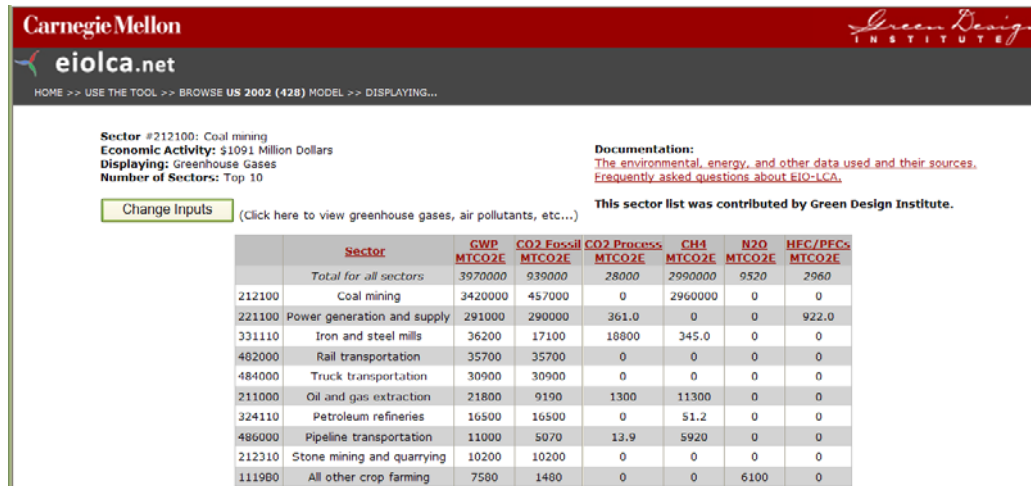

**Figure 11: Example of GHG Outputs Sorted by GWP Column**  
 (Green Design Institute, Carnegie Mellon University, 2009)

### *EIO-LCA Methodology Limitations and Uncertainty*

Any number or thing that we measure or estimate is uncertain. Performing a LCA whether it is a process-based LCA or an EIO-LCA involves estimation. According to a book published by Christ T. Hendrickson along with Lester B. Lave and H. Scott Matthews titled, “Environmental Life Cycle Assessment of Goods and Services: An Input-Output Approach”, the six most important sources of uncertainty in using the EIO-

LCA methodology include: survey errors, old data, incomplete data, missing data, aggregation, and imports. (Hendrickson, Lave, & Matthews, 2006).

Survey errors are caused by the fact the data in the input-output data tables are from industry census surveys by the U.S. BEA. According to Hendrickson et al., “...particular manufacturing plants may produce products for more than one sector. In this case, an allocation must be made of input and outputs associated with the different products, and the allocation method may induce errors” (Hendrickson, et al. 2006). Minimizing these errors depends upon the industries surveyed and the accuracy and completeness of those surveys and cannot be corrected by users of the EIO-LCA methodology.

The data from the input-output table used in this thesis is from 2002 and is over seven years old. Also, the environmental data has a time lag in it. A lot of the industries in 2002 use the same processes as they do in 2010, but it is important to understand the older data is a limitation in using the EIO-LCA methodology. For example, coal mining in 2002 uses the same technology and same processes as it does in 2002, but the emissions from vehicles in 2002 is a lot different than the emissions from vehicles in 2010. Also, because the EIO-LCA on-line software relies on public databases such as the input-output tables, the accuracy and completeness of these databases are uncertain. Some of the data may be overestimated or underestimated. Finally, there may be some missing data from the input-output tables and the environmental databases the EIO-LCA relies upon.

For the U.S. 2002 Benchmark model used in this thesis there may be some aggregation issues or in laymen terms the 428 sectors available in the 2002 model do not

give us information on every process or product. For example, Fischer Tropsch (FT) synthesis to produce liquid jet fuel is not a process available in the U.S. 2002 Benchmark model. Therefore, estimation and assumptions must be made to calculate a GWP due to the GHGs emitted for the LCA stage of producing CBTL via the FT process. Finally, the EIO-LCA methodology treats imports exactly the same as U.S. production of a product or the process to produce that product. There is definitely uncertainty in the EIO-LCA methodology in understanding that every process to produce a given product in this global economy is not completed in the U.S.

Understanding the limitations, uncertainty, and risk of the EIO-LCA methodology is important. The results from comparing JP-8 jet fuel to CBTL jet fuel using the EIO-LCA methodology are uncertain, but a decent approximation as to which jet fuel is “greener” for the environment can be accomplished. The EIO-LCA methodology is only one way to complete a life cycle analysis of two products. The results from using the EIO-LCA methodology is not perfect or certain, but neither would the results if a process LCA was performed on the two jet fuels to determine which one is the “greenest” (less GWP due to the GHGs emitted during its life cycle).

## **Petroleum-Derived Jet Fuel (JP-8) Process**

### ***Overview***

For the purpose of this thesis JP-8 jet fuel will be broken down into typical life cycle assessment stages in order to explain the “Well-to-Wheels/Wake (WTW)” and the “Wells-to-Tank (WTT)” process of producing the petroleum derived jet fuel. A life cycle assessment approach means we recognize our choices at each stage of a product’s

life cycle. Typically, the stages of a product life cycle are: material extraction, material processing, manufacturing, use, and waste management.

In 2008, The National Energy Technology Laboratory (NETL) of the U.S. DOE performed a life cycle assessment to develop the baseline data and analysis of greenhouse gas emissions of petroleum derived fuels. According to the published document titled, “Affordable Low Carbon Diesel Fuel from Coal and Biomass”, “The study goals and scope were aligned to meet the definition of “baseline lifecycle greenhouse gas emissions” as defined in the Energy Independence and Security Act of 2007 (EISA 2007), Title II, Subtitle A, Sec. 201” (National Energy Technical Laboratory, 2008). The DOE NETL’s 2008 report life cycle assessment stages of petroleum derived fuels are shown in Figure 12; the boundary for both the “WTW” and “WTT” LCA stages are shown. The baseline “WTW” GWP for the average diesel fuel sold in the U.S. in 1995 is 95.0 kg CO<sub>2</sub>eq/mmBtu, lower heating value (LHV) and the baseline “WTT” GWP for the same diesel is 18.3 kg CO<sub>2</sub>eq/mmBtu, LHV; the baseline “WTW” GWP for the average kerosene-based jet fuel sold in the U.S. in 1995 is 92.8 CO<sub>2</sub>eq/mmBtu, LHV and the baseline “WTT” GWP for the same kerosene-based jet fuel is 15.1 CO<sub>2</sub>eq/mmBtu, LHV (National Energy Technical Laboratory, 2008).

Figure ES-1. Life Cycle of Petroleum-Based Transportation Fuels

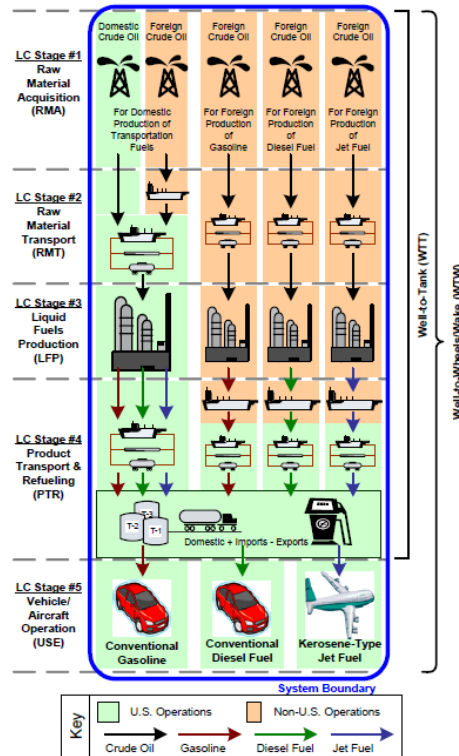

Figure 12: Life Cycle States in NETL Document for Petroleum-Based Fuels  
(National Energy Technical Laboratory, 2008)

The life cycle stages explored in this thesis for both the petroleum derived jet fuel, JP-8 and the alternatively produced jet fuel, CBTL are: 1. Raw Material Extraction (Mining/Agriculture); 2. Raw Material Manufacturing (Refining/Fischer Tropsch); and 3. Jet Fuel Use (Burning Fuel in Flight). The transportation of the material between all three of these stages and its effects on the environment are captured internally by the EIO-LCA on-line tool and incorporated into the total GWP of the GHG emission outputs at each stage. For the purpose of this thesis, the “Jet Fuel Use” life cycle assessment stage is assumed to have the same total GWP for the GHGs emitted during flight for both



JP-8 jet fuel and CBTL jet fuel. According to the DOE NETL's 2008 report the total GWP of the GHGs emitted during the use phase is typically 84% of the total GWP of the GHGs emitted during the entire life cycle for kerosene-based jet fuel. The "Jet Fuel Use" phase for both JP-8 and CBTL jet fuel is assumed to be 84% of the total GWP due to the GHGs emitted for this LCA stage for both jet fuels. A disposal phase is assumed to be non-existent since aircraft burn the fuel and nothing is left to dispose of after the jet fuel is used as an energy source by the aircraft. The petroleum derived jet fuel of JP-8 and its effects on the environment (total GWP for the GHGs emitted) totals will be explored using the EIO-LCA methodology and on-line tool in this thesis. The total GWP for the GHGs emitted for JP-8 will be used to compare the jet fuel to CBTL to determine which jet fuel is "greener" for the environment.

### ***Raw Material Extraction LCA Stage—Oil***

Oil was formed by the remains of plants and animals that lived millions of years ago in a marine environment before dinosaurs. As these organisms lived, they absorbed energy from the sun that was stored as carbon in their bodies. When they died they sank to the bottom of the sea and were buried by layer after layer of sediment. Heat and pressure began to rise as these plants and animals became buried deeper and deeper. The amount of pressure and degree of heat and the type of biomass determined whether they would become oil or natural gas. This oil and natural gas migrated until it became trapped beneath impermeable rock. This is where we find our oil and natural gas today.

Once crude oil exploration is complete; either via seismic surveys, exploration wells, or geomagnetic surveys; and oil is believed to be in the ground at a certain

location, then an oil derrick is set up to support the drill. These drills run on electricity, which is an environmental impact in the Raw Material Extraction phase of the petroleum-based jet fuel that will be captured by the EIO-LCA on-line tool. Since most oil extraction takes place in remote areas the oil drill's electricity is provided by a diesel powered generator. The EIO-LCA on-line tool captures the circularity effect of extracting crude oil by a drill and pump powered with a crude oil refined product of diesel fuel. As the drill cuts into the rock, drilling mud is added to the hole to keep the drill bit cool and counteract any pressure or heat as the hole is drilled and prevent a possible "blow-out" of the well. Finally, a steel casing is added to the hole to prevent any fresh water from aquifers to penetrate the well hole and to keep the freshly drilled hole open.

Once the hole is drilled, then the oil must be extracted. The three most common ways for crude oil to be extracted from the ground are primary, secondary, and enhanced recovery. Primary recovery means rely on the ground pressure to force the oil to the surface first, but then employs pumps once oil stops flowing by natural means. The primary recovery method only yields 10% of the actual oil available in the ground. Secondary recovery pumps the wastewater from the oil well back into the well to force the crude oil to the surface. This method accounts for an additional 20% or a total of 30% of the oil in the ground. Finally, enhanced recovery methods consist of three different methods alone to extract the oil. The first is called thermal and uses steam to force more of the oil to the surface. The second is gas injection and uses different gases such as carbon dioxide, methane, and propane to force the oil to the surface. Finally, chemical flooding involves mixing dense, water-soluble polymers with water and

injecting the mixture into the field to force the crude oil to the surface. Enhanced recovery methods can extract as much as 60% of the oil reserve to the surface.

The extracted oil is typically a mixture of oil, water, and natural gas. Several methods are used to separate these materials for to send to their next phase in processing the raw materials. According to the “Adventures in Energy” webpage on the American Petroleum Institute (API) website, water and natural gas is removed from oil by passing the mixture through a device that removes the gas and sends it into a separate line. Any remaining oil, gas, and water mixture goes into a heater/treater unit. Heating breaks up the mixture and the denser oil separates from the water. The less dense natural gas rises to the top. The gas is removed for either processing or burning; water is removed and stored for further treatment (American Petroleum Institute, 2009). This process can be visually seen in Figure 13.

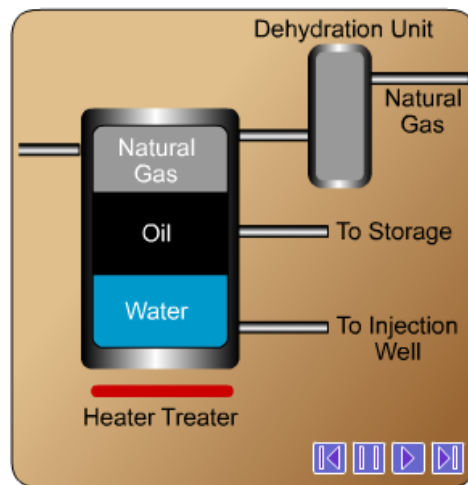

**Figure 13: Typical Heater/Treater Unit to Remove Water and Natural Gas from Oil**

(American Petroleum Institute, 2009)

Another process to separate oil, water, and natural gas is to use a device called a hydrocyclone. Hydrocyclones spin the mixture and uses acceleration to separate the three raw materials. The natural gas is piped out for processing and use. The water from the mixture is usually too salty to be used as a drinking water source, but instead of disposal the water is pumped back into the oil well to aid in forcing more oil from the well. Both the heater/treater unit and hydrocyclone devices use energy to separate the mixture. The Raw Material Extraction life cycle assessment stage of the petroleum derived jet fuel of JP-8 and the related environmental impacts will be captured when the EIO-LCA on-line tool is used to model this stage. The dollar amount inputted into the EIO-LCA on-line tool for the “Raw Material Extraction” LCA stage will be correlated to the amount the USAF used and the cost of jet fuel in FY2008, which was 2.4 billion gallons at a cost of \$7.7 billion (Aimone, 2009). The crude oil extraction cost is typically between 65-70% of the total cost of any given fuel derived from petroleum (Energy Information Administration (a), 2008).

### ***Raw Material Manufacturing—Refining Oil***

The raw material in JP-8 manufacturing is crude oil. The process to manufacture crude oil into the petroleum derived jet fuel of JP-8 is by refining. Every barrel of crude oil is not exactly alike, but on the average Figure 14 shows the per gallon yield from one 42-U.S. gallon barrel of crude oil. When that typical 42 gallon barrel of crude oil is refined it yields slightly more than 44 gallons of petroleum products. The typical 5% gain from refining crude oil is similar to popcorn which gets bigger when it is popped.

As you can see from Figure 14, the typical jet fuel yield from a typical barrel of crude oil is 4.07 gallons or 9.25% of the 44 gallons of petroleum products from a typical barrel of crude oil. The 9.25% is not the exact percentage of the final cost of jet fuel to determine dollar amount of refining activity, but the amount of jet fuel refined from a typical barrel of crude oil. However, according to the U.S. EIA and correlating jet fuel to diesel fuel (because both fuels are distilled about the same temperature) the percentage of final cost of jet fuel for refining is approximately 6% (Energy Information Administration (e), 2009). The “amount of economic activity” for the “Raw Material Manufacturing” LCA stage for JP-8 jet fuel is 6% of the total cost of jet fuel for the USAF in FY 2008, and that dollar amount will be inputted into the EIO-LCA on-line tool to determine the environmental impact of this LCA stage.

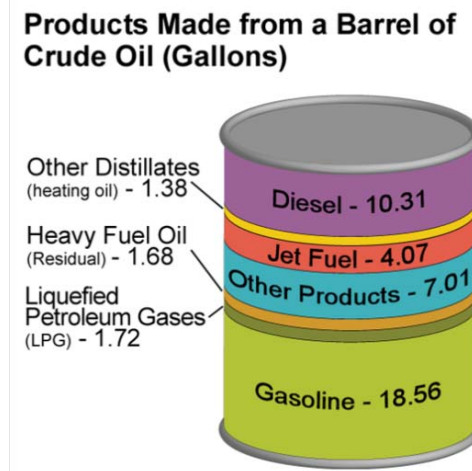

**Figure 14: Typical Yields from 42-U.S. Gallon Barrel of Crude Oil**  
(Energy Information Administration (a), 2008)

Crude oil is made up of different chains of hydrocarbons. Hydrocarbons are basically chains of carbon and hydrogen atoms. The properties of the hydrocarbon are determined by the number of carbon atoms in the chain and how that chain is arranged. For example, the average hydrocarbon in kerosene jet fuel has 12 carbon atoms (Figure 15). The boiling point is the easiest way to tell one kind of hydrocarbon from another. Just as water goes from liquid to vapor at approximately 212° Fahrenheit, each type of hydrocarbon changes from liquid to vapor within a specific temperature range. As a common rule, the more carbons in a molecule, the higher the boiling point (Figure 16).

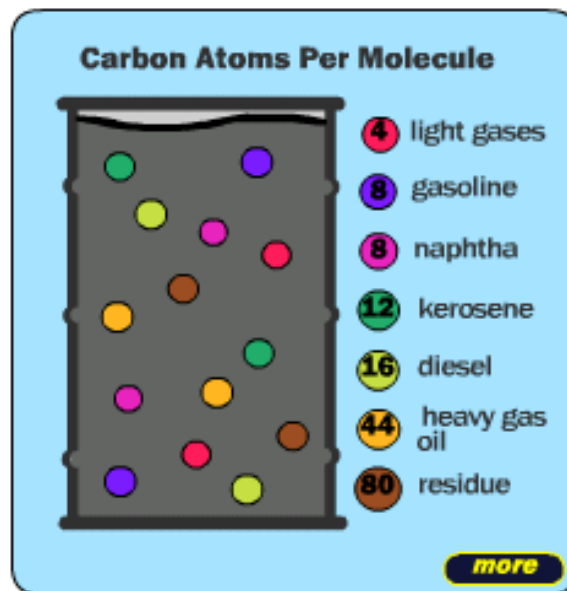

**Figure 15: Typical Carbon Atoms Present in Finished Products from Crude Oil**

(American Petroleum Institute, 2009)

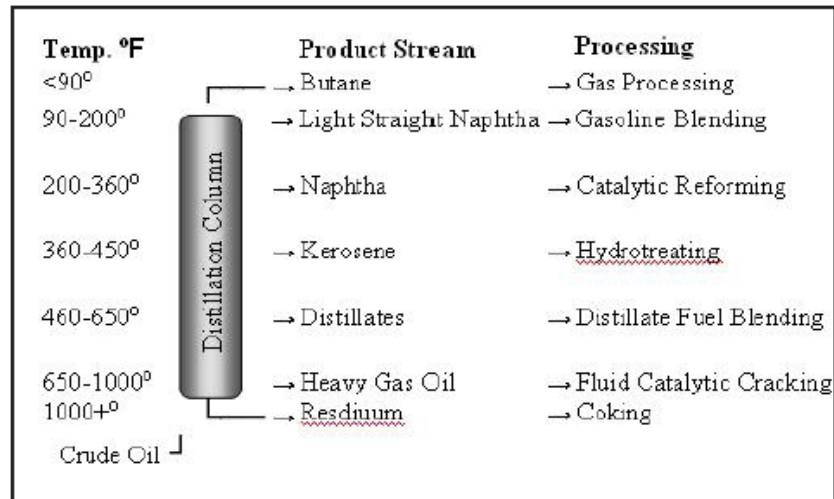

**Figure 16: Petroleum Products Boiling Range, Crude Oil Distillation Process**

(Andrews, 2009)

The first step in refining is cleaning and desalting the crude oil. Then, the crude oil is heated until only waxy residual hydrocarbons remain in liquid form. Mixed hydrocarbon vapors rise through distilling columns as the waxy residual hydrocarbons in liquid form are heated. These vapors cool as they rise from the heat. A hydrocarbon reverts back to liquid form when it cools below its boiling point. Devices called bubble caps are the keys to how a distilling column works. Each collection tray has a network of raised perforations that allow vapor to rise through the tray but prevent the collected liquid from pouring down to the tray below. A bubble cap fits loosely over each perforation forcing the vapor to pass through the hydrocarbon liquid before it continues its upward journey. Contact with the liquid cools the vapor so that the heavier hydrocarbons become liquid, as well.

The petroleum-derived jet fuel the USAF uses, JP-8, is a kerosene based fuel that is categorized as a distillate fuel and is produced from the process explained above. Often distillate, kerosene- based jet fuel is hydrotreated to produce the finished product. According to the API, “In hydrotreating, hydrocarbons and hydrogen are heated together and then fed into a reaction chamber containing a special catalyst. When the hydrocarbon and hydrogen molecules come in contact with the catalyst, a chemical reaction takes place that strips sulfur from the hydrocarbon to form hydrogen sulfide. The hydrogen sulfide is removed and neutralized in a separate process. The sulfur compounds produced from this process are used in other applications such as fertilizers and pharmaceuticals” (American Petroleum Institute, 2009). Finally, to meet the military specifications typical jet fuel is blended with the additives as discussed earlier in the thesis for JP-8.

### ***Jet Fuel Use LCA Stage Petroleum Derived (JP-8)***

The “Jet Fuel Use” LCA stage of the petroleum-derived jet fuel, JP-8, will be the same as the alternatively produced jet fuel, CBTL, when comparing both of the fuels. Jet fuel is burned by aircraft the same way if it is a petroleum derived jet fuel or an alternatively produced jet fuel. For this thesis, the use phase is assumed to have the same impact on the environment for both JP-8 jet fuel and CBTL jet fuel since any fuel used by the USAF must meet strict specifications and have almost identical properties during use. The major difference in comparing JP-8 to CBTL is in the raw materials to produce each fuel and the refining process to turn those materials into jet fuel.



## Coal-Biomass to Liquid (CBTL) Production Process

### *Overview*

For the purpose of this thesis the alternative jet fuel of CBTL will be broken down into typical LCA stages in order to explain the “WTW” process of producing the alternative fuel. Again, a LCA approach means we recognize our choices at each stage of a product’s life cycle. Typically, the stages of a product life cycle are: material extraction, material processing, manufacturing, use, and waste management. This thesis uses the EIO-LCA on-line tool to perform a LCA to determine whether JP-8 (petroleum-derived jet fuel) or CBTL (alternatively produced jet fuel) is “greener” for the environment (less total GWP due to the GHGs emitted).

In January, 2009, the DOE’s NETL published a report stating that CBTL fuels can compete economically with current petroleum-derived fuels and be produced so that they are exactly compatible with current fuel infrastructure and current transportation vehicles, including aircraft. According to the report titled, “Development of Baseline Data and Analysis of Life Cycle Greenhouse Gas Emissions of Petroleum Based Fuels”, “Coal and Biomass to Liquids (CBTL) with a mixture of 8% (by weight) biomass and 92% (by weight) coal—can produce fuels which are economically competitive when crude oil prices are equal to or above \$93/bbl and which have 20% lower life cycle Greenhouse Gas (GHG) emissions than petroleum-derived fuel” (National Energy Technology Laboratory, 2009). If the percentage of biomass is increased, then the price of crude oil needs to be even greater. Currently, the average price for a barrel of crude oil in the world is about \$74/bbl (Energy Information Administration (b), 2009). CBTL is

not economically competitive in the current market, but the NETL report determined it to have lower GHG emissions than petroleum-derived fuel and it can be produced from domestic sources limiting the amount of foreign crude oil the United States imports.

The CBTL process uses three existing technologies to produce liquid fuels: carbon capture and storage (CCS), gasification, and Fischer Tropsch (FT) synthesis. CCS is the capture, transport, and long-term storage of CO<sub>2</sub> to reduce GHG emissions and the climate change impact of a process. CCS can either be simple (>91% carbon captured) or aggressive (>95% carbon captured). As can be expected aggressive CCS is more expensive than simple CCS, and the Required Selling Price (RSP) of the CBTL fuel increases if this type of carbon capture is used. The DOE NETL's 2009 report states, "Coal-Biomass to Liquids (CBTL) is a commercial process which converts coal and biomass into diesel fuel, producing a concentrated stream of CO<sub>2</sub> as a byproduct. Coupling the process with carbon sequestration is relatively inexpensive (adding only 7 cents per gallon to the RSP of the diesel product)" (National Energy Technology Laboratory, 2009). Adding only 7 cents to the RSP of every gallon of CBTL by adding carbon sequestration allows for the alternative fuel to be affordable and potentially have GHG emissions lower than typical petroleum derived fuel resulting in a lower total GWP during the fuel's life cycle. Gasification is breaking down the coal and biomass into carbon monoxide (CO) gas and hydrogen (H<sub>2</sub>) gas, commonly referred to as "syngas". FT synthesis takes the "syngas" and reacts it with a catalyst (such as iron (Fe) or cobalt (Co)) to form hydrocarbons of varying lengths, of which the majority can be converted to liquid fuels.

Again, the life cycle stages explored in this thesis for both the petroleum derived jet fuel, JP-8 and the alternatively produced jet fuel, CBTL are: 1. Raw Material Extraction (Mining/Agriculture); 2. Raw Material Manufacturing (Refining/Fischer Tropsch); and 3. Jet Fuel Use (Burning Fuel in Flight). The transportation of the material between all three of these stages and its effects on the environment are captured internally by the EIO-LCA on-line tool and incorporated into the GWP of the GHG outputs at each stage. A disposal phase is assumed to be non-existent since aircraft burn the fuel and nothing is left to dispose of after the jet fuel is used as an energy source by the aircraft. The “Jet Fuel Use” LCA stage is considered to have the same total GWP total for both JP-8 and CBTL jet fuels.

### ***Raw Material Extraction LCA Stage—Coal and Biomass***

#### *Coal*

Like crude oil, coal is a nonrenewable energy source that was formed millions of years ago as plants and animals died, decayed, were buried, and through heat and pressure were turned into the brownish-black or black sedimentary rock containing mostly carbons and hydrocarbons. There are four types of coal: anthracite (86-97% carbon), bituminous (45-86% carbons), subbituminous (35-45% carbon), and lignite (25-35% carbon). The most abundant coal in the United States (U.S.), accounting for about 50% of the U.S. coal production, is bituminous found mainly in the states of Illinois West Virginia, Kentucky, and Pennsylvania. Illinois #6, a high-sulfur bituminous coal was the only coal used in the NETL study on CBTL fuel and will be the only coal considered in this thesis. The cost, according to the EIA website, was \$41.50 per short ton for Illinois

#6 coal at the time this thesis was written (Energy Information Administration (f), 2010).

Figure 17 shows the estimated location of the various coal reserves in the U.S according to the American Coal Foundation (ACF).

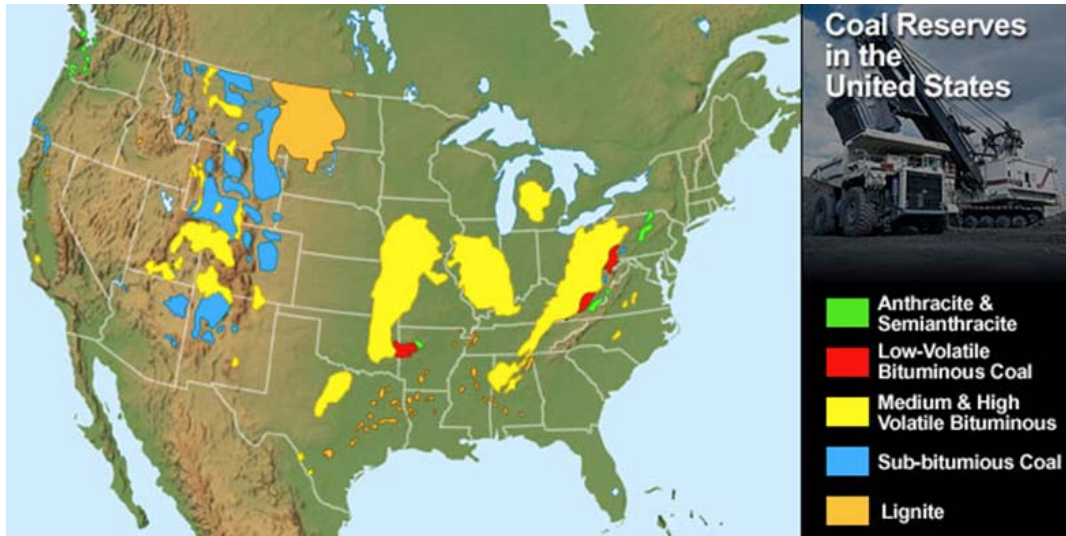

**Figure 17: United States Estimated Coal Reserves**

(American Coal Foundation, 2007)

Coal is mined by either surface mining or deep mining. In surface mining, large machines such as draglines, wheel excavators, and large shovels remove the topsoil and subsoil and set it aside to be used in reclaiming the land after the mining operation. The removed material is called overburden. Next, explosives break the coal into manageable sizes. Then, the coal is removed and loaded into trucks. Finally, the area is refilled with the overburden, covered with the top soils that were removed, and reseeded for vegetation. Coal companies do their best to reclaim the land to its original state after surface mining. In underground mining, two openings called shafts are drilled into the

coal bed—the first to transport miners and equipment, and the second to bring coal to the surface. Next, either explosives or rotating cutters break the coal into manageable sizes. Finally, the coal is brought to the surface by elevators, conveyor belts, or coal cars (American Coal Foundation, 2007).

### *Biomass*

The only biomass considered in this thesis for use in the production of the CBTL jet fuel was switchgrass. The reason switchgrass was chosen is because it is the biomass the NETL used in their 2009 report about CBTL fuel. According to the report, “Switchgrass is herbaceous biomass which can be grown throughout the United States including on degraded or marginal lands. A key issue surrounding the use of biomass as an energy feedstock is land use change, i.e. energy crops competing for lands used for food crops or causing non-croplands to be developed for cultivation, resulting in the release of stored carbon from these lands” (National Energy Technology Laboratory, 2009).

Switchgrass is a perennial plant and native to the original tall grass prairies of the United States (U.S.). In a report written by Blade Energy Crops, “Switchgrass has been identified by the U.S. Department of Energy as a leading dedicated energy crop because it tolerates a wide range of environmental conditions and offers high biomass yield, compared to many other perennial grasses and conventional crop plants” (Blade Energy Crops, 2009). Figure 18 shows what typical switchgrass looks like when growing in the wild or on a farm. Switchgrass has a lot of potential in the renewable energy market since it does not deplete food sources and it can be grown on degraded or marginal farm

land where other crops cannot. There are many other forms of biomass that could be used to produce CBTL fuels, but for this thesis switchgrass was the only one considered.

Switchgrass is harvested in the field like other crops and left to field dry to a 15% moisture (by weight). As with the NETL report, an assumption of 15% (by weight) of the cultivated crop is lost during harvesting. The field dried switchgrass is collected, baled, and covered with tarps to store in the field. Another assumption of 10% (by weight) of the stored switchgrass will be lost due to biomass degradation during the storage phase. The switchgrass bales studied in this thesis are round bales with the dimensions of 5 ft. wide by 5.5 ft in diameter (Popp & Hogan, 2009) . These bales of harvested switchgrass are stored in the field until they are needed at the plant. The yield of an acre of switchgrass in this thesis is assumed to be 5 dry tons, which is the typical yield for years 3 to 12 of a mature switchgrass farm (Popp & Hogan, 2009). The round bales are transported via truck or rail for further processing at the plant for conversion to liquid fuel, and cost approximately \$53 at the biorefinery (Popp & Hogan, 2009).



**Figure 18: Typical Switchgrass**

(Blade Energy Crops, 2009)

## ***Raw Material Manufacturing LCA Stage—Coal and Biomass***

### *Overview*

As stated above in the thesis, both coal and biomass must be prepared for conversion to liquid fuel by indirect liquefaction using the FT synthesis process. This thesis considers a FT synthesis, CBTL jet fuel plant configured to produce the maximum amount of liquid jet fuel (production of co-products such as electricity was minimized). Various plant configurations of no CCS, simple CCS, and aggressive CCS are explored in the DOE NETL's 2009 report. However, this thesis only considered a biorefinery without CCS and with simple CCS methods for the manufacturing of the alternative jet fuel, CBTL. Figure 19 shows a diagram of a typical CBTL plant with simple CCS. The only difference is the plant in the diagram is configured to produce a certain amount electricity, and the plant studied in this thesis corresponds to the one studied in the 2009 NETL report and was configured to maximize the amount of liquid fuel produced.

Since the EIO-LCA methodology is based on current manufacturing processes in the U.S. and the Fischer Tropsch indirect liquefaction production of jet fuel is not a current manufacturing process in U.S., the on-line tool cannot be used to determine the environmental impacts of the “Raw Material Manufacturing” LCA stage for CBTL. The U.S. DOE NETL's 2009 report and the total GWP due to the GHGs emitted during the FT refining stage published in the report are used in this thesis to compare JP-8 and CBTL for the “Raw Material Manufacturing” LCA stage to determine which fuel is “greener” for the environment. The published GHG emission rates are based on a CBTL plant configured for maximum liquid fuel output with and without simple CCS methods.



The following paragraphs briefly explain the process to produce liquid jet fuel from coal and biomass.

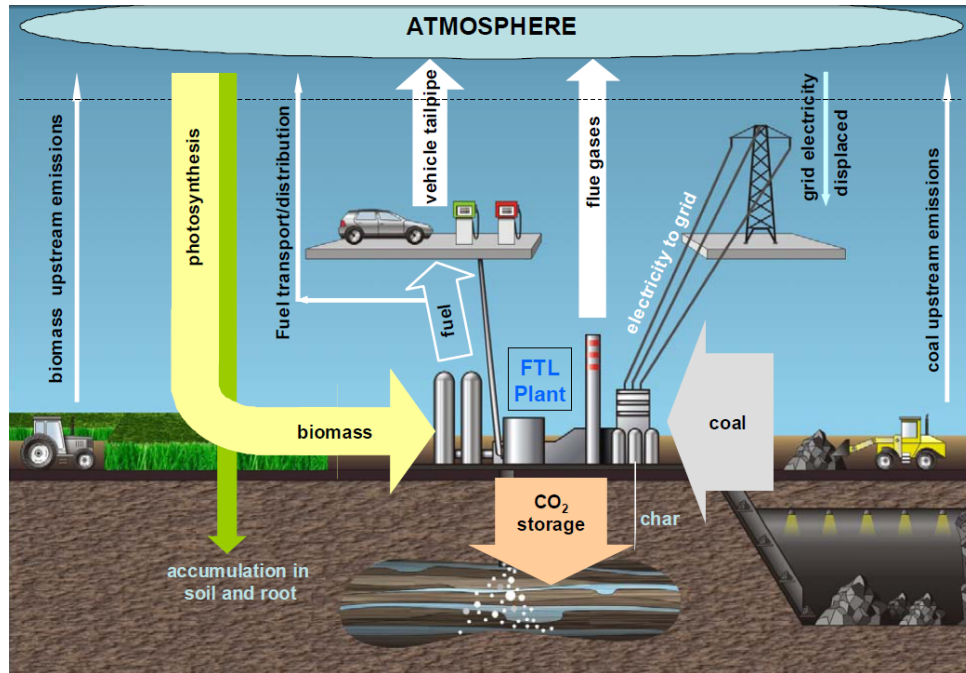

**Figure 19: Typical CBTL Liquid Fuel Plant with Simple CCS**

(Kreutz, 2008)

### *Feedstock Process and Drying*

First, the bales of switchgrass are transported to the CBTL plant by a truck. At the plant, a de-baler breaks up the bales into loose grass. The waste heat from the de-baler is used to dry the biomass to 10% moisture (by weight) before it is fed into the grinder. Since biomass is more reactive than coal it does not have to be ground as fine, however, grinding to a size of one millimeter or less ensures proper feeding into the gasifier. Next, it is dried to a 5% moisture (by weight) to get the biomass ready for the



gasifier. Coal is transported to the plant via rail and is crushed and ground to a size distribution which is 17% less than 200 mesh. Coal is also dried to 5% moisture (by weight) prior to feed into the gasifier.

#### *Co-Gasification of Coal and Biomass*

According to the NETL report, “In CTL and CBTL cases, a single stage, dry feed, entrained-flow gasifier was used to gasify the coal and/or biomass. This type of gasifier was chosen due to operating experience in co-firing biomass and the advantage that it produces no tars and a minimal amount of methane (CH<sub>4</sub>) (which does not react in the FT synthesis process). The gasifier is of the slagging type and a direct contact water quench spray system is used to cool the syngas exiting the gasifier. The quench also removes particulate matter and contaminants not removed in the slag. However, because the ash from biomass is rich in calcium oxide, it is difficult to melt even at the high gasifier operating temperature (2600°F) and additional fluxing agents may be required to obtain acceptable slag properties. It is assumed in this study that the gasifier design has to be modified to include the two separate feed systems and dedicated biomass burners. The advantage of having separate feed systems would be that, if the biomass system becomes inoperable for a time because of plugging, the gasifier can continue to operate on coal only” (National Energy Technology Laboratory, 2009).

#### *Fischer Tropsch Synthesis*

“Synthetic” liquid fuels such as diesel and jet fuels can be created from carbonaceous feedstocks (such as coal and biomass) using the FT process. According to the DOE NETL’s 2009 report the FT process is a proven technology that dates back to

WWII. The following describes the proven technology, “FT synthesis is a commercial process which was utilized extensively in Germany through the end of World War II. It is currently being utilized commercially by SASOL and Petro-SA in South Africa, by Shell in Malaysia, and by SASOL in Qatar. The South Africa plants were deployed 25-30 years ago, and while SASOL has continued an active R&D program since then, no large scale facilities were built in the remainder of the 20th century. The 66,000 bpd Gas to Liquids plant currently under construction in Qatar represents the first large scale deployment of an FT synthesis plant by SASOL in 25 years” (National Energy Technology Laboratory, 2009).

Solid feedstocks, such as coal or biomass, are first broken up into CO and H<sub>2</sub> by gasification and gas cleaning to create “syngas”. FT synthesis takes the “syngas” and reacts it with a catalyst (such as iron (Fe) or cobalt (Co)) to form hydrocarbons of varying lengths, of which the majority can be converted to liquid fuels. This chemical conversion is shown in Figure 20. These hydrocarbons are the basic molecular building blocks that result in liquid fuels that are essentially free of sulfur (S) and aromatic compounds found in petroleum derived fuels.

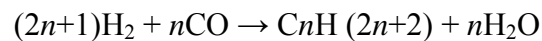

**Figure 20: Chemical Conversion of Hydrocarbons  
(Basic Building Blocks of Jet Fuel via FT Synthesis)**

(National Energy Technology Laboratory, 2009)

According to the DOE NETL's 2009 report, "The FT reactor used is a low temperature (360-480°F), slurry phase reactor which contains an iron (Fe) catalyst. This reactor design and operating configuration are optimized for the production of long carbon chain hydrocarbons that can be selectively hydrocracked into diesel fuel and jet fuel, along with the minimization of oxygenates. Slurry reactors also give a higher conversion per pass because of their superior heat transfer characteristics. Fe is used as catalyst because it is less expensive than cobalt (Co) and readily obtained in the U.S." (National Energy Technology Laboratory, 2009).

### *Carbon Sequestration*

Carbon (C) sequestration is accomplished by carbon capture and storage (CCS). According to NETL report, "CCS is the capture, transport, and long-term storage of CO<sub>2</sub> to reduce GHG emissions and the climate change impact of a process" (National Energy Technology Laboratory, 2009). In this case the process is the Fischer Tropsch synthesis process to produce liquid jet fuel. CCS can be accomplished in two different ways which are "simple CCS" and "aggressive CCS". "Simple CCS" is a case where the CO<sub>2</sub> produced by the FT plant is compressed, transported, and stored in a geological formation resulting in >91 percent of the CO<sub>2</sub> produced by the plant is captured. "Aggressive CCS" is achieved through the use of an Auto-Thermal Reformer (ATR), an additional Water Gas Shift (WGS) unit, and a revised recycle stream resulting in >95 percent of the CO<sub>2</sub> produced by the plant is captured. The no CCS and the "simple CCS" cases are used in this thesis.

### ***Jet Fuel Use LCA Stage Alternatively Produced (CBTL)***

The “Jet Fuel Use” LCA stage of the alternatively produced jet fuel, CBTL, will be the same as the petroleum derived jet fuel, JP-8, when comparing both of the fuels. Jet fuel is burned by aircraft the same way if it is an alternatively produced jet fuel or a petroleum derived jet fuel. For this thesis, the use phase is assumed to have the same impact on the environment for both CBTL jet fuel and JP-8 jet fuel since any fuel used by the USAF must meet strict specifications and have almost identical properties during use. The major difference in comparing CBTL and JP-8 is in the raw materials to produce each fuel and the refining process to turn those materials into jet fuel.

## Chapter III: Methodology

### Overview

Chapter III describes how the EIO-LCA methodology estimates the materials and energy resources required for, and the environmental emissions resulting from, activities in our economy with the cradle-to-grave LCA of the petroleum derived jet fuel of JP-8 and the alternatively produced from coal and biomass jet fuel of CBTL. (Green Design Institute, Carnegie Mellon University, 2009). First, the basis for using the EIO-LCA methodology is explained. Next, an overview of the mathematical calculations behind the EIO-LCA methodology is discussed. Finally, the “amount of economic activity” and how it was calculated and derived associated with each life cycle assessment stage: 1. Raw Material Extraction (Mining/Agriculture); 2. Raw Material Manufacturing (Refining/Fischer Tropsch); and 3. Jet Fuel Use (Burning Fuel in Flight) for each jet fuel is explained in detail in this chapter.

### Using the EIO-LCA Model

The 2002 U.S. Benchmark (Producer Price) EIO-LCA model was used in this thesis to assess the environmental impacts (total GWP due to GHGs emitted during the fuel’s entire life cycle) associated with the three life cycle stages stated above for both JP-8 jet fuel and CBTL jet fuel. Again, the LCA stage of “Jet Fuel Use” (Burning in Flight) is assumed to have the same total GWP due to the GHGs emitted for each jet fuel. The costs for the resource required at each life cycle stage for both of these jet fuels were inputted into the 2002 U.S. Benchmark EIO-LCA model and the summed total GWP due

to the GHGs emitted for each jet fuel was compared. In order to display the results effectively in Chapter IV, the “Top 10” sectors with the highest to lowest total GWP in mt CO<sub>2</sub>eq due to the GHGs emitted are displayed for each life cycle assessed for each jet fuel as outputted from the EIO-LCA 2002 U.S. Benchmark model. The total GWP for each LCA for each jet fuel was then converted to kg CO<sub>2</sub>eq/mm Btu for proper comparison. Each of the totals for each of the LCA stages for each jet fuel were then summed to determine the overall GWP due to the GHGs emitted during the entire life cycle of each jet fuel analyzed. The jet fuel with the lowest total GWP in kg CO<sub>2</sub>eq/mmBtu, LHV was determined to be the “greenest” for the environment.

### **EIO-LCA Model Steps and Calculations**

To use the EIOLCA model, the user must first determine which life cycle stage is under consideration and how best to determine the cost of the resources required for the product, process, or service in the life cycle stage being assessed. For example, if the user was interested in the environmental impacts of the “Raw Material Extraction” LCA stage for JP-8 jet fuel, they would need to know the approximate cost for extracted material (crude oil) required to produce JP-8. If the user was interested in looking at the environmental impacts of the “Raw Material Manufacturing” LCA stage for JP-8 jet fuel, they would need to determine the cost of refining crude oil into jet fuel. The resulting environmental impacts would then need to be summed, as discussed above, to arrive at an environmental “WTT” LCA for JP-8 jet fuel.

The mathematical example of how the EIO-LCA methodology works is explained in the following excerpt published by Professor Conway-Schempf from Carnegie Mellon

University in a case study for students to explore and learn the EIO-LCA methodology.

She states,

“The EIO-LCA mathematical analysis occurs in several stages. First, the model is started by specifying an increase or decrease in demand for a sector. For example, switching from steel to aluminum for some automobile components would be represented by an increase in aluminum demand and a decrease in the demand for steel output. Second, the economic input-output model is used to estimate both direct and indirect changes in output throughout the economy for each sector. Third, the environmental discharges of the changes are assessed by multiplying the economy-wide output changes by the average environmental discharges associated with unit output of each sector. The overall environmental impact is characterized by this vector of discharges and by selected summary indices. These steps are presented in the following mathematical form.

The EIO-LCA model first calculates the change in all commodity demands due to an increase in final demand of a specific sector. If  $X$  is the change in total commodity output (a 500 entry vector in dollars),  $I$  is an identity matrix (to include the output of the of the specific sector),  $D$  is the requirements matrix (a 500 by 500 matrix showing the purchases from other commodity sectors for the production of a specific sector), and  $F$  is a vector representing the desired final demand. Then the total output including indirect suppliers is:  $X = (I-D)^{-1}F$

Once the economic output for each stage is calculated, then a vector of direct environmental outputs can be obtained by multiplying the output at each stage by the environmental impact or dollar of output:  $B_i = R_iX = R_i(I-D)^{-1}F$  where  $B_i$  is

the vector of environmental burdens (such as toxic emissions or electricity use), and  $R_i$  is a matrix with diagonal elements representing the impact per dollar of output for each stage. A large variety of environmental burdens can be included in this calculation” (Conway-Schempf, 2007).

The detailed mathematical calculations behind the EIO-LCA methodology and on-line tool can be found in Appendix A of this thesis.

### **EIO-LCA Tool Applied to Comparing JP-8 and CBTL Jet Fuel**

The following diagram (Figure 21) shows how each jet fuel, JP-8 and CBTL, was compared performing a LCA using both the EIO-LCA methodology and the DOE NETL’s 2009 report on CBTL fuel. The EIO-LCA tool is used to compare both fuels in the “Raw Material Extraction” LCA stage. However, for the “Raw Material Manufacturing” LCA stage the EIO-LCA tool is used to determine the total GWP due to the GHGs emitted for JP-8 jet fuel, but the total GWP for CBTL jet fuel is from the 2009 NETL report. The reason the EIO-LCA tool cannot be used for CBTL jet fuel in the “Raw Material Manufacturing” LCA stage is the indirect liquefaction of coal and biomass using the FT synthesis process is not a standard industry in the U.S.; therefore, there is not an appropriate industry or sector to represent this stage using the EIO-LCA on-line tool. The “Jet Fuel Use” LCA stage for both JP-8 jet fuel and CBTL jet fuel was assumed to have the same total GWP due to the GHGs emitted for both jet fuels, again resulting in a “WTT” LCA comparison.





## Which is “Greener”? JP-8 or CBTL



Life Cycle Assessment Stages	JP-8 Jet Fuel	CBTL Jet Fuel
1. Raw Material Extraction	Crude Oil Extraction <i>(GHG rates from EIO-LCA)</i>	Coal Mining Biomass-Planting/Harvest <i>(GHG rates from EIO-LCA)</i>
2. Raw Material Manufacturing	Refining Crude Oil <i>(GHG rates from EIO-LCA)</i>	Fischer Tropsch Synthesis <i>(GHG rates-NETL report-some conversion needed)</i>
3. Jet Fuel Use	<u>**Use Assumed to be Same for Both Jet Fuels</u>	<u>**Use Assumed to be Same for Both Jet Fuels</u>

**Figure 21: Comparing JP-8 to CBTL Jet Fuel**

In order to compare JP-8 jet fuel to CBTL jet fuel to determine which fuel is “greener” for the environment a baseline of comparison was established. The USAF used 2.4 billion gallons of jet fuel in FY 2008 for the cost of \$7.7 billion (Aimone, 2009). The FY 2008 numbers were used as a baseline in this thesis to compare JP-8 to CBTL primarily using the EIO-LCA methodology. Costs for each LCA stage were established corresponding to the FY 2008 baseline by using published information through research. The next two sections explain how the “amount of economic activity” required by using the EIO-LCA on-line tool for each LCA stage for each jet fuel was calculated.

## EIO-LCA Tool Applied to JP-8

The cost for each LCA stage for JP-8 jet fuel was determined by dissecting each stage into a percentage of what it typically costs to extract and refine crude oil into a finished product. According to the U.S. EIA, the final cost of a typical transportation diesel fuel is broken down by the percentages shown in Figure 22. The figure shows the percentages for diesel fuel, but as explained in Chapter II refining crude oil into diesel or kerosene based jet fuel, such as JP-8, is completed by heating the crude oil to similar temperatures along the distillation column (Figure 23). The current percentages, as of November 2009, in Figure 22 were used to determine the cost associated for both the “Raw Material Extraction” and “Raw Material Manufacturing” LCA stages for JP-8 jet fuel. The environmental impacts (total GWP due to the GHGs emitted) during the “Jet Fuel Use” LCA were assumed to be equal in this thesis for both jet fuels.

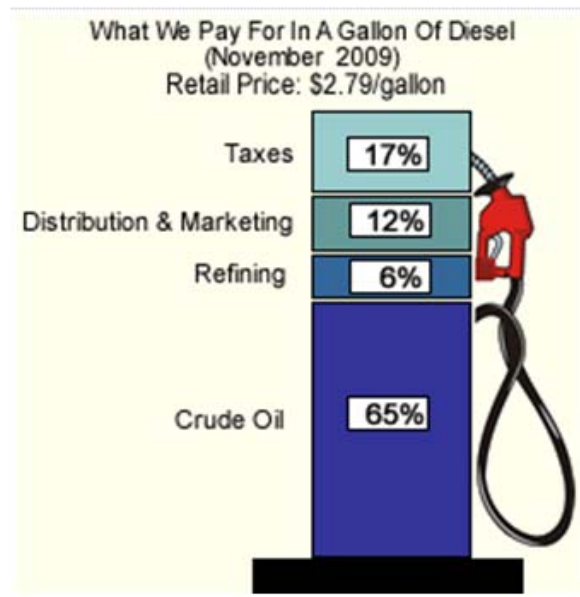

**Figure 22: Diesel Fuel Percentages Correlated to JP-8 Jet Fuel**

(Energy Information Administration (e), 2009)

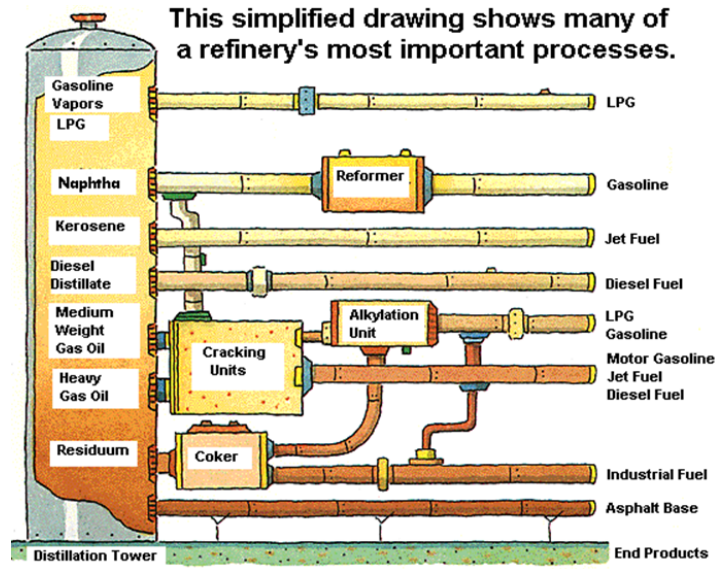

**Figure 23: Diesel Fuel and Jet Fuel Similar on Common Distillation Tower**

(Energy Information Administration (c), 2008)

### *Raw Material Extraction LCA Stage Analysis JP-8 Jet Fuel*

The cost of crude oil is approximately 65% the total cost of JP-8 jet fuel (Figure 22). Considering the AF spent \$7.7 billion on jet fuel in FY 2008, then the cost of the “Raw Material Extraction” LCA stage for JP-8 equals  $(\$7.7 \text{ billion} \times 0.65)$  \$5.005 billion. This figure was input into the EIO-LCA on-line tool to determine the environmental impact of the “Raw Material Extraction” LCA stage for JP-8 jet fuel. Figure 24 shows a “screenshot” of an example of using the U.S. 2002 Benchmark tool available at [www.eiolca.net](http://www.eiolca.net). As you can see, the “amount of economic activity” for the industry of “mining and utilities” and detailed sector of “oil and gas extraction” is \$5,005 million or \$5.005 billion. The results selected were “Greenhouse Gases”, and the “Top 10” sectors with the highest to lowest GWP due to the GHGs emitted by extracting

\$5,005 million or \$5.005 billion of crude oil are presented in Chapter IV. The results are presented as a “screenshot” of the actual EIO-LCA output. The conversion from mt CO<sub>2</sub>eq to kg CO<sub>2</sub>eq/mm Btu, LHV is presented in a table in Chapter IV for “Raw Material Extraction” LCA stage for JP-8 jet fuel.

The screenshot shows the EIO-LCA On-Line Tool interface with the following steps:

- 1 Choose a model:** Your current model is the **US 2002 Benchmark**, which is a **Producer Price Model**. (Show more details)  
US 2002 (428)
- 2 Select industry and sector:** Search for a sector by keyword: [Search]  
Or browse for a sector below:  
Mining and Utilities | Oil and gas extraction
- 3 Select the amount of economic activity for this sector:** 5005 Million Dollars (Show more details)
- 4 Select the category of results to display:** Greenhouse Gases (Show more details)
- 5 Run the model:**

**Figure 24: Using the EIO-LCA On-Line Tool**

(Green Design Institute, Carnegie Mellon University, 2009)

### ***Raw Material Manufacturing LCA Stage Analysis JP-8 Jet Fuel***

The cost of refining crude oil into JP-8 jet fuel is approximately 6% of the total cost of the jet fuel (Figure 3.2). Again, considering the USAF spent \$7.7 billion on jet fuel in FY 2008, then the cost of the “Raw Material Manufacturing” LCA stage for JP-8 equals ( $\$7.7 \text{ billion} \times 0.06$ ) \$462 million. \$462 million was input into the U.S. 2002 Benchmark EIO-LCA on-line tool to determine the environmental impact of the “Raw

Material Manufacturing” LCA stage for JP-8 jet fuel. The industry of “petroleum and basic chemical” and the detailed sector of “petroleum refineries” were selected and the “amount of economic activity” inputted into the on-line tool was \$462 million. The results selected were “Greenhouse Gases”, and the “Top 10” sectors affected by refining \$462 million of crude oil into JP-8 jet fuel are presented in Chapter IV. The conversion from mt CO<sub>2</sub>eq to kg CO<sub>2</sub>eq/mm Btu, LHV is presented in a table in Chapter IV for the “Raw Material Manufacturing” LCA stage for JP-8 jet fuel.

### **EIO-LCA Tool Applied to CBTL**

CBTL jet fuel is compared with JP-8 jet fuel by using the U.S. 2002 Benchmark model available at the EIO-LCA website to determine which jet fuel is “greener” (lowest total GWP due to the GHGs emitted) for the environment. The initial CBTL jet fuel analyzed in this thesis contains 92% by weight coal and 8% by weight switchgrass (biomass). Again, the USAF’s consumption of 2.4 billion gallons of jet fuel for the cost of \$7.7 billion in FY 2008 was used as the baseline when determining the cost associated with each LCA stage for CBTL using the EIO-LCA methodology. The next section explains how the “amount of economic activity” was calculated for each coal and biomass (switchgrass) for the “Raw Material Extraction” LCA stage for CBTL jet fuel. Again, the total GWP due to the GHGs emitted for the “Raw Material Manufacturing” LCA stage for CBTL jet fuel is extracted from the DOE, NETL’s 2009 report on CBTL fuel since direct liquefaction of coal and biomass via the FT synthesis process to produce liquid jet fuel is not an established industry in the U.S.

## ***Raw Material Extraction LCA Stage Analysis CBTL Jet Fuel***

### *Illinois #6 Bituminous Coal Analysis*

Again, the initial CBTL jet fuel analyzed in this thesis is 92% coal by weight. To produce an equivalent amount of jet fuel from coal the USAF's FY 2008 jet fuel use of 2.4 billion gallons is multiplied by 92% to determine the number of gallons produced from coal. The answer is  $(2.4 \text{ billion} \times 0.92)$  2.208 billion gallons of jet fuel from coal. According to a report published for the Nation Center for Policy Analysis (NCPA) written by Nicolas Ducote and H. Sterling Burnett, "...it takes approximately one-half a short ton of coal to produce a barrel of CTL diesel" (Ducote & Burnett, 2009). A U.S. barrel (bbl), when speaking about oil or petroleum is equivalent to 42 U.S. gallons. 2.208 billion gallons divided by 42 equals 52,571,429 bbls. Multiply that figure by  $\frac{1}{2}$  to find out how many short tons of coal is needed to produce 2.208 billion gallons of jet fuel from coal. The answer is 26,285,714 short tons of coal. According to the EIA website (Figure 25), a short ton of Illinois #6 bituminous coal costs \$41.50 as of January 15, 2010 (Energy Information Administration (f), 2010). In order to determine the "amount of economic activity" of coal inputted into the EIO-LCA on-line tool, \$41.50 is multiplied by 26,285,714. The answer is approximately \$1.091 billion or \$1,091 million since the EIO-LCA on-line tool requires the cost to be in millions of U.S. dollars.

Average Weekly Coal Commodity Spot Prices (Dollars per Short Ton)					
Week Ended	Central Appalachia 12,500 Btu, 1.2 SO <sub>2</sub>	Northern Appalachia 13,000 Btu, <3.0 SO <sub>2</sub>	Illinois Basin 11,800 Btu, 5.0 SO <sub>2</sub>	Powder River Basin 8,800 Btu, 0.8 SO <sub>2</sub>	Uinta Basin 11,700 Btu, 0.8 SO <sub>2</sub>
12/11/09	\$54.15	\$50.60	\$40.50	\$8.40	\$40.00
12/18/09	\$54.15	\$50.69	\$40.50	\$8.40	\$40.00
12/24/09	N/A	N/A	N/A	N/A	N/A
12/31/09	\$57.40	\$52.50	\$40.50	\$9.25	\$40.00
01/08/10	\$57.95	\$54.00	\$40.50	\$9.80	\$40.00
01/15/10	\$57.95	\$54.00	\$41.50	\$9.80	\$40.00

**Figure 25: Cost of Illinois #6 Bituminous Coal (U.S. \$ per Short Ton)**

(Energy Information Administration (f), 2010)

The “amount of economic activity” of \$1,091 million was input into the EIO-LCA on-line tool to determine the environmental impact (total GWP due to the GHGs emitted) for the coal portion of the “Raw Material Extraction” LCA stage for CBTL jet fuel. The industry of “mining and utilities” and the detailed sector of “coal mining” were selected using the 2002 U.S. Benchmark model using the EIO-LCA on-line tool. The results selected were “Greenhouse Gases”, and the “Top 10” sectors affected by extracting \$1,091 million of Illinois #6 bituminous coal to produce an equivalent amount of CBTL jet fuel compared with JP-8 jet fuel are presented in Chapter IV. The conversion from mt CO<sub>2</sub>eq to kg CO<sub>2</sub>eq/mm Btu, LHV is presented in a table in Chapter IV for the coal portion of the “Raw Material Extraction” LCA stage for CBTL jet fuel.

### *Switchgrass (Biomass) Analysis*

Again, the initial CBTL jet fuel analyzed in this thesis is 8% switchgrass (biomass) by weight. To produce an equivalent amount of jet fuel from switchgrass, the USAF's FY 2008 jet fuel use of 2.4 billion gallons is multiplied by 8% to determine the number of gallons produced from switchgrass. The answer is  $(2.4 \text{ billion} \times 0.08)$  192 million gallons of jet fuel from switchgrass. According to a report by Michael Popp and Robert Hogan, two professors from the University of Arkansas, it costs approximately \$53.00 per dry ton of switchgrass at the biorefinery (Popp & Hogan, 2009). The initial CBTL plant configuration analyzed in this thesis is 8% switchgrass and 92% coal by weight, and this plant's production capacity is 50,000 barrels per day (BPD) of CBTL fuel. Also, the maximum amount of switchgrass is 4,000 dry tons per day for the CBTL plant analyzed. (National Energy Technology Laboratory, 2009). Multiplying 50,000 BPD by 8% equals 4,000 BPD produced from the switchgrass. So, it takes 1 dry ton of switchgrass to produce 1 bbl of CBTL fuel. To calculate the number of dry tons of switchgrass needed, 192 million gallons is divided by 42 (42 U.S. gals in one barrel of fuel). The answer is approximately 4,572 million dry tons of switchgrass needed to produce 8% of the total gallons used by the USAF in FY 2008. The "amount of economic activity" inputted for the switchgrass (biomass) portion to produce CBTL jet fuel equals  $(4,572 \text{ million} \times \$53.00)$  approximately \$242 million.

The "amount of economic activity" of \$242 million was input into the EIO-LCA on-line tool to determine the environmental impact (total GWP due to the GHGs emitted) for the switchgrass (biomass) portion of the "Raw Material Extraction" LCA stage for CBTL jet fuel. Using the U.S. 2002 Benchmark model of the EIO-LCA on-line tool, the



industry selected was “agriculture, livestock, forestry, and fisheries” and the detailed sector selected was “all other crop farming”. This detailed sector contains the NAICS sector code of 111940 (hay farming), which is the closest agriculture industry to farming switchgrass (biomass). The results selected were “Greenhouse Gases”, and the “Top 10” sectors affected by farming \$242 million of switchgrass (biomass) to produce an equivalent amount of CBTL jet fuel compared with JP-8 jet fuel are presented in Chapter IV. The conversion from mt CO<sub>2</sub>eq to kg CO<sub>2</sub>eq/mm Btu, LHV is also presented in a table in Chapter IV for the switchgrass (biomass) portion of the “Raw Material Extraction” LCA stage for CBTL jet fuel.

### ***Raw Material Manufacturing LCA Stage Analysis CBTL Jet Fuel***

The “Raw Material Manufacturing” LCA stage cannot be analyzed using the EIO-LCA methodology and on-line tool for the CBTL jet fuel. The indirect liquefaction using the FT synthesis process to convert coal and biomass to liquid jet fuel is not an established industry in the U.S., and an “industry” and “detailed sector” does not exist within the U.S. 2002 Benchmark model tool available at the EIO-LCA website. The DOE NETL’s 2009 report concluded the “well to wheels (WTW)” GHG emissions for a CBTL fuel with 8% switchgrass (biomass) and 92% coal by weight was 76.0 kg CO<sub>2</sub>eq/per million (mm) Btu, Lower Heating Value (LHV), of fuel consumed (Figure 26) (National Energy Technology Laboratory, 2009). Assuming CBTL liquid fuel production is similar across the board (Figure 3.5) and similar to petroleum kerosene type jet fuel production (Figure 27), then 6% of the total “WTW” GHG emissions over the entire life cycle of a fuel accounts for the total GWP during liquid fuel production

(refining/FT synthesis). Under these assumptions, then the total GWP for the “Raw Material Manufacturing” LCA stage for CBTL is (76.0 kg CO<sub>2</sub>eq/mmBtu, LHV X 0.06) 4.5600 kg CO<sub>2</sub>eq/mmBtu, LHV. However, since the DOE NETL’s 2009 report removed 46.1% of the CO<sub>2</sub> produced by the plant then the “WTW” GHG Emissions for Case 4 in Figure 26 is actually  $76.0/0.539 = 141$  kg CO<sub>2</sub>eq/mmBtu, LHV. The total GWP for the “Raw Material Manufacturing” LCA stage for 8% switchgrass (biomass) and 92% coal is (141 kg CO<sub>2</sub>eq/mmBtu, LHV X 0.06) 8.46 kg CO<sub>2</sub>eq/mmBtu, LHV without CCS.

Case	1	2	3	4	5	6	7	8	9	10	11
Description	CTL	CTL	CTL	CBTL	CBTL	CBTL	CBTL	CBTL	BTL	BTL	BTL
CCS	None	Simple	ATR	Simple	Simple	Simple	ATR	ATR	None	Simple	ATR
Biomass %	n/a	n/a	n/a	8wt%	15wt%	30wt%	15wt%	30wt%	100%	100%	100%
WTW GHG Emissions (kg CO <sub>2</sub> eq/mmBtu)	235	90.2	83.7	76.0	63.4	35.1	55.3	23.8	-8.8	-210.0	-245.0
% Change from Petroleum	+147%	-5%	-12%	-20%	-33%	-63%	-42%	-75%	-9.2%	-321%	-358%

**Figure 26: GHG Emissions of CBTL Plants Compared to the Petroleum Baseline of Conventional Diesel of 95 kg CO<sub>2</sub>eq/mmBtu, LHV**

(National Energy Technology Laboratory, 2009)

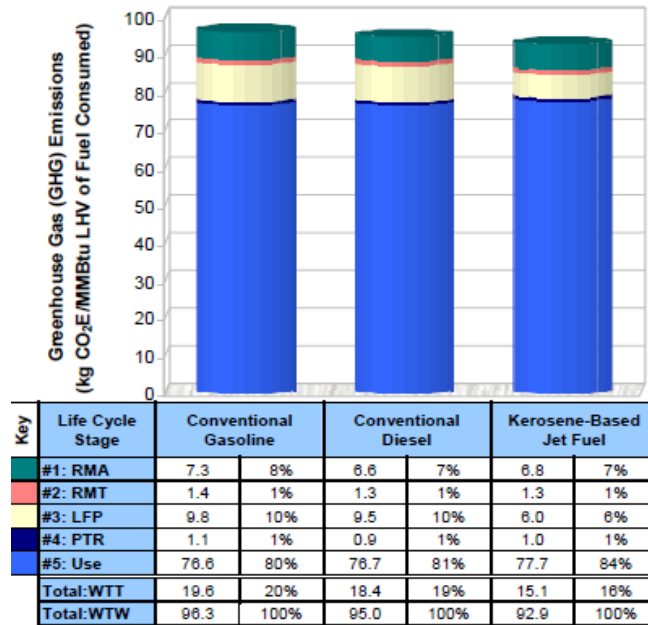

**Figure 27: Typical Percentage GHGs (CO<sub>2</sub>eq) of Petroleum Derived Liquid Fuel Production**

(National Energy Technical Laboratory, 2008)

Again, since the EIO-LCA on-line tool reports the total GWP due to the GHGs emitted in mt CO<sub>2</sub>eq and the DOE NETL's 2009 report presents the total GWP due to the GHGs emitted in kg CO<sub>2</sub>eq/mmBtu, then a conversion is necessary in order to sum the EIO-LCA results with the DOE NETL report's results to compare CBTL to JP-8 jet fuel. There are 1000 kgs in 1 mt, and the LHV of 1 U.S. barrel of kerosene-based jet fuel is 5.230 mmBtu, LHV (Table 3), so the LHV of 1 U.S. gallon of kerosene-based jet fuel is:

$$(5.230 \text{ mmBtu} \div 1 \text{ bbl}) \times (1 \text{ bbl} \div 42 \text{ gals}) = 0.124524 \text{ mmBtu/gal}$$

The conversion factor to convert mt CO<sub>2</sub>eq to kg CO<sub>2</sub>eq/mmBtu, LHV is:

$$[1000 \text{ kg} \div 1 \text{ mt}] \times [1 \div (0.124524 \text{ mmBtus/gal} \times \text{number of gallons jet fuel})]$$

The resulting conversions from mt CO<sub>2</sub>eq to kg CO<sub>2</sub>eq/mmBtu, LHV are presented in the tables in Chapter IV for each LCA stage for each jet fuel.

**Table 3: Lower Heating Value (LHV) of Kerosene Based Jet Fuel**

(National Energy Technical Laboratory, 2008)

Property	Conventional Gasoline	Conventional Diesel Fuel	Kerosene-Based Jet Fuel
Lower Heating Value (LHV), MMBtu/bbl	4.892	5.512	5.230
Density, lb/gal	6.16	7.07	6.70
Vehicle Fuel Efficiency, MPG	23.7	31.2	Not Applicable
Vehicle Total Fuel Use, Btu LHV/mile	4,866	3,737	Not Applicable
Use Phase GHG Emissions, kg CO <sub>2</sub> E/MMBtu LHV	76.6	76.7	77.7
Use Phase GHG Emissions, kg CO <sub>2</sub> E/mile	0.373	0.286	Not Applicable

## Chapter IV: Results and Discussion

### Overview

This chapter presents the results of the LCA by comparing the environmental impacts of JP-8 and CBTL jet fuels during each fuel's entire life cycle. The EIO-LCA methodology was used to make the comparison. The emphasis will be information relevant to the research objective presented in Chapter I to determine which jet fuel, JP-8 or CBTL, is "greener" for the environment. The following is a thorough assessment of the results of the total GWP of the GHGs emitted for each jet fuel over their entire life cycle.

### JP-8 Jet Fuel EIO-LCA Results

#### *Raw Material Extraction LCA Stage Results JP-8 Jet Fuel*

The "Top 10" GWP contributing sectors from the GHGs emitted from inputting \$5,005 million for the "amount of economic activity" and choosing the industry of "mining and utilities" and the detailed sector of "oil and gas extraction" using the U.S. 2002 Benchmark model available on the EIO-LCA website are shown below (Figure 28) for the "Raw Material Extraction" LCA stage for JP-8. The largest GWP contributing sector is the "oil and gas extraction" sector with the "power generation and supply" sector as the second largest contributor. The results from the EIO-LCA tool are given in mt CO<sub>2</sub>eq, and the total of all sectors for GWP is approximately 7,210,000 mt CO<sub>2</sub>eq. Table 4 shows the conversion to kg CO<sub>2</sub>eq/mmBtu, LHV from mt CO<sub>2</sub>eq, which is necessary because the DOE NETL's 2009 report on CBTL fuel reports its results in kg

CO<sub>2</sub>eq/mmBtu, LHV. Again, this report’s results are necessary to determine the total GWP due to the GHGs emitted for the “Raw Material Manufacturing” LCA stage for CBTL jet fuel because indirect liquefaction using the FT synthesis process cannot be analyzed using the EIO-LCA methodology. According to the conversion, the total GWP from the GHGs emitted for the “Raw Material Extraction” LCA stage for JP-8 jet fuel is approximately 24.1 kg CO<sub>2</sub>eq/mmBtu, LHV.

**Sector** #211000: Oil and gas extraction  
**Economic Activity:** \$5005 Million Dollars  
**Displaying:** Greenhouse Gases  
**Number of Sectors:** Top 10

**Documentation:**  
[The environmental, energy, and other data used and their sources](#)  
[Frequently asked questions about EIO-LCA.](#)

(Click here to view greenhouse gases, air pollutants, etc...)

**This sector list was contributed by Green Design Institut**

	<b>Sector</b>	<b>GWP MTCO<sub>2</sub>E</b>	<b>CO<sub>2</sub> Fossil MTCO<sub>2</sub>E</b>	<b>CO<sub>2</sub> Process MTCO<sub>2</sub>E</b>	<b>CH<sub>4</sub> MTCO<sub>2</sub>E</b>	<b>N<sub>2</sub>O MTCO<sub>2</sub>E</b>	<b>HFC/PFCs MTCO<sub>2</sub>E</b>
	<i>Total for all sectors</i>	7210000	3800000	404000	2940000	14000	54400
211000	Oil and gas extraction	5420000	2290000	323000	2810000	0	0
221100	Power generation and supply	990000	986000	1230	0	0	3140
486000	Pipeline transportation	90200	41500	114.0	48500	0	0
230301	Nonresidential maintenance and repair	83600	83600	0	0	0	0
324110	Petroleum refineries	70500	70300	0	218.0	0	0
331110	Iron and steel mills	66100	31100	34300	629.0	0	0
325120	Industrial gas manufacturing	55200	6750	0	0	0	48400
327310	Cement manufacturing	53400	22300	31100	0	0	0
212100	Coal mining	46800	6240	0	40500	0	0
484000	Truck transportation	28300	28300	0	0	0	0

**Figure 28: GHGs for \$5,005 Million "Raw Material Extraction" LCA Stage JP-8, EIO-LCA**

(Green Design Institute, Carnegie Mellon University, 2009)

**Table 4: Conversion to kg CO<sub>2</sub>eq/mmBtu, LHV (Top 10 Sectors);  
“Raw Material Extraction Stage” JP-8 Jet Fuel**

(Green Design Institute, Carnegie Mellon University, 2009)

	A	B	C	D	E	F	G	H	I
1			# of Gallons Jet Fuel	2,400,000,000					
2			TOTAL (mt CO <sub>2</sub> eq)	7,210,196.74	3,797,603.07	404,280.97	2,939,906.68	13,956.23	54,441.89
3			TOTAL (kg CO <sub>2</sub> eq/mm Btu, LHV)	24.1259	12.7071	1.3528	9.8371	0.0467	0.1822
4	#	NAISC	Sector	GWP	CO <sub>2</sub> Fossil	CO <sub>2</sub> Process	CH <sub>4</sub>	N <sub>2</sub> O	HFC/PFCs
5		Code		mt CO <sub>2</sub> eq	mt CO <sub>2</sub> eq	mt CO <sub>2</sub> eq	mt CO <sub>2</sub> eq	mt CO <sub>2</sub> eq	mt CO <sub>2</sub> eq
6	1	211000	Oil and gas extraction	5,421,346.14	2,286,788.29	323,406.09	2,811,144.51	0.00	0.00
7	2	221100	Power generation and supply	990,487.93	986,120.12	1,229.73	0.00	0.00	3,137.42
8	3	486000	Pipeline transportation	90,166.47	41,545.92	113.86	48,506.45	0.00	0.00
9	4	230301	Nonresidential maintenance and repair	83,634.89	83,634.89	0.00	0.00	0.00	0.00
10	5	324110	Petroleum refineries	70,506.11	70,287.78	0.00	218.46	0.00	0.00
11	6	331110	Iron and steel mills	66,095.93	31,148.99	34,318.48	628.54	0.00	0.00
12	7	325120	Industrial gas manufacturing	55,179.44	6,748.42	0.00	0.00	0.00	48,431.13
13	8	327310	Cement manufacturing	53,432.02	22,326.16	31,105.65	0.00	0.00	0.00
14	9	212100	Coal mining	46,753.05	6,243.96	0.00	40,509.11	0.00	0.00
15	10	484000	Truck transportation	28,319.38	28,319.38	0.00	0.00	0.00	0.00

### **Raw Material Manufacturing LCA Stage Results JP-8 Jet Fuel**

The “Top 10” GWP contributing sectors from the GHGs emitted from inputting \$462 million for the “amount of economic activity” and choosing the industry of “petroleum and basic chemical” and the detailed sector of “petroleum refineries” using the U.S. 2002 Benchmark model available on the EIO-LCA website are shown below (Figure 29) for the “Raw Material Manufacturing” LCA stage for JP-8. The largest GWP contributing sector is the “petroleum refineries” sector with the “oil and gas extraction” sector as the second largest contributor. The results from the EIO-LCA tool are given in mt CO<sub>2</sub>eq, and the total of all sectors for GWP is approximately 1,110,000 mt CO<sub>2</sub>eq. Table 5 shows the conversion to kg CO<sub>2</sub>eq/mmBtu, LHV from mt CO<sub>2</sub>eq. The total GWP due to the GHGs emitted for the “Raw Material Manufacturing” LCA stage for JP-8 jet fuel is approximately 3.7 kg CO<sub>2</sub>eq/mmBtu, LHV.

Sector #324110: Petroleum refineries  
 Economic Activity: \$462 Million Dollars  
 Displaying: Greenhouse Gases  
 Number of Sectors: Top 10

Documentation:  
[The environmental, energy, and other data used and the Frequently asked questions about EIO-LCA.](#)

Change Inputs

(Click here to view greenhouse gases, air pollutants, etc...)

This sector list was contributed by Green Design Ins

	Sector	GWP MTCO2E	CO2 Fossil MTCO2E	CO2 Process MTCO2E	CH4 MTCO2E	N2O MTCO2E	HFC/PFCs MTCO2E
	Total for all sectors	1100000	830000	30300	231000	2300	4460
324110	Petroleum refineries	481000	479000	0	1490	0	0
211000	Oil and gas extraction	375000	158000	22400	195000	0	0
221100	Power generation and supply	118000	118000	147.0	0	0	375.0
486000	Pipeline transportation	43000	19800	54.3	23100	0	0
230301	Nonresidential maintenance and repair	6670	6670	0	0	0	0
331110	Iron and steel mills	5750	2710	2990	54.7	0	0
325190	Other basic organic chemical manufacturing	5560	4890	0	0	674.0	0
325110	Petrochemical manufacturing	5390	4560	605.0	230	0	0
484000	Truck transportation	5250	5250	0	0	0	0
212100	Coal mining	5210	695.0	0	4510	0	0

Figure 29: GHGs for \$462 Million for "Raw Material Manufacturing" LCA Stage JP-8, EIO-LCA

(Green Design Institute, Carnegie Mellon University, 2009)

Table 5: Conversion to kg CO<sub>2</sub>eq/mmBtu, LHV (Top 10 Sectors)  
 "Raw Material Manufacturing Stage", JP-8 Jet Fuel

(Green Design Institute, Carnegie Mellon University, 2009)

	A	B	C	D	E	F	G	H	I
1			# Gallons of Jet Fuel	2,400,000.000					
2			TOTAL (mt CO <sub>2</sub> eq)	1,097,329.0388	829,620.6962	30,306.9825	230,646.5995	2,298.9371	4,456.0658
3			TOTAL (kg CO <sub>2</sub> eq/mm Btu, LHV)	3.6717	2.7760	0.1014	0.7718	0.0077	0.0149
4	#	NAISC Code	Sector	GWP mt CO <sub>2</sub> eq	CO <sub>2</sub> , Fossil mt CO <sub>2</sub> eq	CO <sub>2</sub> , Process mt CO <sub>2</sub> eq	CH <sub>4</sub> mt CO <sub>2</sub> eq	N <sub>2</sub> O mt CO <sub>2</sub> eq	HFC/PFCs mt CO <sub>2</sub> eq
5									
6	1	324110	Petroleum refineries	480,563.8853	479,075.7662	0.0000	1,489.0204	0.0000	0.0000
7	2	211000	Oil and gas extraction	375,418.2752	158,355.8939	22,395.2784	194,666.6008	0.0000	0.0000
8	3	221100	Power generation and supply	118,246.3644	117,724.9266	146.8076	0.0000	0.0000	374.5509
9	4	486000	Pipeline transportation	42,960.4183	19,794.8341	54.2517	23,111.2251	0.0000	0.0000
10	5	230301	Nonresidential maintenance and repair	6,668.1641	6,668.1641	0.0000	0.0000	0.0000	0.0000
11	6	331110	Iron and steel mills	5,753.5620	2,711.4780	2,987.3779	54.7139	0.0000	0.0000
12	7	325190	Other basic organic chemical manufacturing	5,563.1302	4,889.3582	0.0000	0.0000	673.7782	0.0000
13	8	325110	Petrochemical manufacturing	5,394.7845	4,560.1096	605.1540	229.5405	0.0000	0.0000
14	9	484000	Truck transportation	5,252.4551	5,252.4551	0.0000	0.0000	0.0000	0.0000
15	10	212100	Coal mining	5,205.2899	695.1769	0.0000	4,510.1148	0.0000	0.0000



## CBTL Jet Fuel EIO-LCA Results

### *Raw Material Extraction LCA Stage Results CBTL Jet Fuel*

#### *Coal Portion Results*

The “Top 10” GWP contributing sectors from the GHGs emitted from inputting \$1,091 million for the “amount of economic activity” and choosing the industry of “mining and utilities” and the detailed sector of “coal mining” using the U.S. 2002 Benchmark model available on the EIO-LCA website are shown below (Figure 30) for the coal portion of the “Raw Material Extraction” LCA stage for CBTL. The largest GWP contributing sector is the “coal mining” sector with the “power generation and supply” sector as the second largest contributor. The results from the EIO-LCA tool are given in mt CO<sub>2</sub>eq, and the total of all sectors for GWP is approximately 3,970,000 mt CO<sub>2</sub>eq.

The conversion to kg CO<sub>2</sub>eq/mmBtu, LHV from mt CO<sub>2</sub>eq must include the switchgrass (biomass) portion of the “Raw Material Extraction” LCA stage for an accurate comparison of producing an equivalent amount of CBTL jet fuel compared to the baseline of 2.4 billion U.S. gallons of JP-8 jet fuel. The conversion does not take into account simple CCS which removes >91% of the carbon from the total GWP due to the GHGs emitted for the initial CBTL plant configuration of 92% by weight coal and 8% by weight switchgrass (biomass). The conversion of the total GWP from the coal portion and the switchgrass portion of CBTL jet fuel is shown in the next section.

Sector #212100: Coal mining  
 Economic Activity: \$1091 Million Dollars  
 Displaying: Greenhouse Gases  
 Number of Sectors: Top 10

Documentation:  
[The environmental, energy, and other data used and their  
 Frequently asked questions about EIO-LCA.](#)

Change Inputs

(Click here to view greenhouse gases, air pollutants, etc...)

This sector list was contributed by Green Design Instit

	Sector	GWP MTCO2E	CO2 Fossil MTCO2E	CO2 Process MTCO2E	CH4 MTCO2E	N2O MTCO2E	HFC/PFCs MTCO2E
	Total for all sectors	3970000	939000	28000	2990000	9520	2960
212100	Coal mining	3420000	457000	0	2960000	0	0
221100	Power generation and supply	291000	290000	361.0	0	0	922.0
331110	Iron and steel mills	36200	17100	18800	345.0	0	0
482000	Rail transportation	35700	35700	0	0	0	0
484000	Truck transportation	30900	30900	0	0	0	0
211000	Oil and gas extraction	21800	9190	1300	11300	0	0
324110	Petroleum refineries	16500	16500	0	51.2	0	0
486000	Pipeline transportation	11000	5070	13.9	5920	0	0
212310	Stone mining and quarrying	10200	10200	0	0	0	0
111980	All other crop farming	7580	1480	0	0	6100	0

**Figure 30: GHGs for \$1,091 Million for “Raw Material Extraction” LCA Stage (Coal Portion) CBTL Jet Fuel, EIO-LCA**

(Green Design Institute, Carnegie Mellon University, 2009)

*Switchgrass (Biomass) Portion Results*

The “Top 10” GWP contributing sectors from the GHGs emitted from inputting \$242 million for the “amount of economic activity” and choosing the industry of “agriculture, livestock, forestry, and fisheries” and the detailed sector of “all other crop farming” using the U.S. 2002 Benchmark model available on the EIO-LCA website are shown below (Figure 31) for the switchgrass (biomass) portion of the “Raw Material Extraction” LCA stage for CBTL jet fuel. The largest GWP contributing sector is the “all other crop farming” sector with the “power generation and supply” sector as the second largest contributor. The results from the EIO-LCA tool are given in mt CO<sub>2</sub>eq, and the total of all sectors for GWP is approximately 636,000 mt CO<sub>2</sub>eq.

The conversion to kg CO<sub>2</sub>eq/mmBtu, LHV from mt CO<sub>2</sub>eq for both the coal portion and the switchgrass (biomass) portion for the “Raw Material Extraction” LCA

stage for the initial CBTL plant configuration of 92% by weight coal and 8% by weight switchgrass (biomass) is approximately 15.4 kg CO<sub>2</sub>eq/mmBtu, LHV (4,606,000 mt CO<sub>2</sub>eq × 1000 kg) ÷ (0.124524 LHV × 2,400,000,000 U.S. gallons). This result is without taking a 50% CO<sub>2</sub>eq credit for using switchgrass (biomass) as discussed in Chapter II because of the UDRI 2010 report titled, “Characterizing the Greenhouse Gas Footprints of Aviation Fuels from Fischer-Tropsch Processing” (University of Dayton Research Institute, 2010).

Sector #1119B0: All other crop farming  
 Economic Activity: \$242 Million Dollars  
 Displaying: Greenhouse Gases  
 Number of Sectors: Top 10

**Documentation:**

[The environmental, energy, and other data used and their s](#)  
[Frequently asked questions about EIO-LCA.](#)

Change Inputs

(Click here to view greenhouse gases, air pollutants, etc...)

This sector list was contributed by Green Design Instit

	Sector	GWP MTCO2E	CO2 Fossil MTCO2E	CO2 Process MTCO2E	CH4 MTCO2E	N2O MTCO2E	HFC/PFCs MTCO2E
	Total for all sectors	636000	258000	25900	25800	325000	1100
1119B0	All other crop farming	328000	64200	0	0	264000	0
221100	Power generation and supply	112000	112000	139.0	0	0	355.0
325310	Fertilizer Manufacturing	54500	12800	22600	0	19100	0
1111B0	Grain farming	44100	5880	0	3260	34900	0
324110	Petroleum refineries	18300	18300	0	56.7	0	0
211000	Oil and gas extraction	17200	7240	1020	8900	0	0
484000	Truck transportation	8430	8430	0	0	0	0
1121A0	Cattle ranching and farming	5990	349.0	0	2760	2880	0
486000	Pipeline transportation	3950	1820	4.99	2130	0	0
112A00	Animal production, except cattle and poultry and eggs	3350	410	0	1920	1020	0

**Figure 31: GHGs for \$242 Million for Raw Material Extraction Stage (Switchgrass), CBTL Jet Fuel, EIO-LCA**

(Green Design Institute, Carnegie Mellon University, 2009)

**Raw Material Manufacturing LCA Stage Results CBTL Jet Fuel**

As stated previously in this thesis multiple times, the “Raw Material Manufacturing” LCA stage cannot be analyzed using the EIO-LCA methodology and on-line tool for the CBTL jet fuel. The indirect liquefaction using the FT synthesis process to convert coal and biomass to liquid jet fuel is not an established industry in the U.S.,

and an “industry” and “detailed sector” does not exist within the U.S. 2002 Benchmark model tool available at the EIO-LCA website. The DOE NETL’s 2009 report titled, “Affordable, Low Carbon Diesel Fuel from Coal and Biomass”, concluded the “well to wheels/wake (WTW)” GHG emissions for a CBTL fuel with 8% biomass (switchgrass) and 92% coal by weight was 76.0 kg CO<sub>2</sub>eq/mm Btu, LHV, of fuel consumed (National Energy Technology Laboratory, 2009).

Again, assuming CBTL liquid fuel production is similar whether it is producing diesel fuel or kerosene-based jet fuel, then 6% of the total “WTW” GHG emissions over the entire life cycle of a fuel accounts for the total GWP during liquid fuel production (refining/FT synthesis). Figure 27 in Chapter III shows that refining kerosene based jet fuel typically contributes to 6% of the total GWP due to the GHGs emitted during the jet fuel’s entire life cycle. Under the assumption diesel fuel and jet fuel are produced in similar manners and refining typically contributes to 6% of the total GWP of the jet fuel, then the total GWP for the “Raw Material Manufacturing” LCA stage for CBTL is approximately (76.0 kg CO<sub>2</sub>eq/mmBtu, LHV × 0.06) 4.6 kg CO<sub>2</sub>eq/mmBtu, LHV. However, since the DOE NETL’s 2009 report removed 46.1% of the CO<sub>2</sub> produced by the plant then the “WTW” GHG Emissions for Case 4 in Figure 26 is actually 76.0/0.539 = 141 kg CO<sub>2</sub>eq/mmBtu, LHV. The total GWP for the “Raw Material Manufacturing” LCA stage for 8% switchgrass (biomass) and 92% coal is approximately (141 kg CO<sub>2</sub>eq/mmBtu, LHV × 0.06) 8.5 kg CO<sub>2</sub>eq/mmBtu, LHV without CCS.

## **Which Jet Fuel is “Greener”, JP-8 or CBTL?**

Each jet fuel, JP-8 and CBTL, was explored by performing a “cradle-to-grave” life cycle assessment to determine the total GWP for the GHGs emitted at each LCA stage to determine which jet fuel is “greener” for the environment. The three life cycle assessment stages, 1. Raw Material Extraction (Mining/Agriculture); 2. Raw Material Manufacturing (Refining/Fischer Tropsch); and 3. Jet Fuel Use (Burning Fuel in Flight) were analyzed for both JP-8 and CBTL jet fuel. The “Jet Fuel Use” LCA stage was assumed to have the same total GWP for the GHGs emitted for each jet fuel. This assumption is based on the fact that if any alternative jet fuel is used by the USAF it must meet the exact same strict specifications as the current petroleum derived jet fuel, JP-8. Also, any alternative jet fuel used by the USAF will more than likely be used as a 50/50 blend (jet fuel blendstock) with JP-8 to avoid degradation of flight safety. Therefore, the EIO-LCA of both JP-8 and CBTL in this thesis was essentially a “well-to-tank (WTT)” analysis since the “Jet Fuel Use” LCA stage is assumed to be the same.

The EIO-LCA methodology and the U.S. 2002 Benchmark model available at the EIO-LCA website was used to determine the total GWP of the GHGs emitted at each LCA stage for each jet fuel and the results were presented above. Table 6 summarizes those results for Case 1 (92% coal by weight and 8% switchgrass by weight without simple CCS). JP-8 jet fuel has a total GWP of the GHGs emitted of approximately 27.80 kg CO<sub>2</sub>eq/mmBtu, LHV according to the EIO-LCA results of this thesis. CBTL jet fuel (Case 1) has a total GWP of the GHGs emitted of approximately 23.88 kg CO<sub>2</sub>eq/mmBtu, LHV according to the EIO-LCA results of this thesis and the extrapolated data from the DOE NETL’s 2009 report on CBTL fuel for the “Raw Materials

Manufacturing” LCA stage for CBTL jet fuel. According to the work completed in this thesis by comparing JP-8 and CBTL jet fuel (Case 1) through an EIO-LCA, CBTL jet fuel has a 14% less GWP due to the GHGs emitted over its entire life cycle. CBTL jet fuel is “greener” (less GWP of the GHGs emitted during its life cycle) for the environment for Case 1. Additional cases with and without simple CCS are discussed in the next section.

**Table 6: Summary of Results, CBTL Plant Configuration Case 1 (92% by weight Coal and 8% by weight Switchgrass)**

(Green Design Institute, Carnegie Mellon University, 2009)

	A	B	C
1	<b><u>Initial CBTL Plant Configuration (92% by weight Coal/8% by weight switchgrass) without Simple CCS &gt;91% CO<sub>2</sub> Captured</u></b>		
2	<b><u>Life Cycle Assessment Stage</u></b>	<b><u>Life Cycle Assessment Stage Result GWP of GHGs Emitted (kg CO<sub>2</sub> eq/mm Btu.</u></b>	
3		<b><u>JP-8, Petroleum Derived Jet Fuel</u></b>	<b><u>Coal-Biomass to Liquid (CBTL) Jet Fuel</u></b>
4	<b><u>1. Raw Material Extraction Stage</u></b>	24.13	15.42
5	<b><u>2. Raw Material Manufacturing Stage</u></b>	3.67	8.46
6	<b><u>3. Jet Fuel Use Stage</u></b>	**Assumed to be Same	**Assumed to be Same
7	<b><u>TOTAL</u></b>	<b>27.80</b>	<b>23.88</b>
8	<b><u>PERCENT DIFFERENCE</u></b>	<b>14%</b>	
9	<b><u>** The CBTL jet fuel emits 14% less GHGs and is therefore better for the environment CBTL jet fuel is the "Greener" Jet Fuel for Case 1</u></b>		

## Discussion

### Overview

The total GWP decrease of 14% for CBTL jet fuel (Case 1 without simple CCS) 92% by weight coal and 8% by weight switchgrass (biomass) is “greener” than the JP-8 jet fuel analyzed in this thesis, but does not meet the EISA 2007 standard. The standard

is any new renewable fuel must have a 20% or less total GWP due to the GHGs emitted during its life cycle compared to the baseline “WTT” total of 15.10 kg CO<sub>2</sub>eq/mmBtu, LHV for kerosene-based jet fuels. The CBTL “WTT” GWP due to the GHGs emitted for Case 1 during its entire life cycle of approximately 23.88 kg CO<sub>2</sub>eq/mmBtu, LHV is approximately 57.6% greater than the established baseline of 15.10 kg CO<sub>2</sub>eq/mmBtu, LHV for kerosene-based jet fuels. Any new CBTL jet fuel, or any renewable jet fuel for that matter, must have a “WTT” GWP due to the GHGs emitted during its life cycle of 12.08 kg CO<sub>2</sub>eq/mmBtu, LHV or less, which is 20% less than the established baseline, to meet the EISA 2007 standard for kerosene-based jet fuels.

The initial CBTL plant configuration analyzed in this thesis was 92% coal by weight and 8% switchgrass (biomass) by weight. In theory increasing the percentage of switchgrass (biomass) and decreasing the percentage of coal will lower the total GWP due to the GHGs emitted during the life cycle of the renewable fuel. This theory is based on the results as presented in Figure 26 in Chapter III from the DOE NETL’s 2009 report on CBTL fuel. The different CBTL plant configurations without CCS explored through the EIO-LCA methodology using the U.S. 2002 Benchmark model available at the EIO-LCA website prove the theory to be correct, but not as “drastic” as presented in the DOE NETL’s 2009 report on CBTL fuel. This is discussed in the following section.

***CBTL Jet Fuel Plant Cases Explored without CCS (50% CO<sub>2</sub>eq credit for switchgrass)***

Table 7 summarizes the results using the EIO-LCA methodology and U.S. 2002 Benchmark model available at the EIO-LCA website of several different CBTL plant



configurations without CCS to include a 100% biomass-to-liquid (BTL) and a 100% coal-to-liquid (CTL) case. The “greenest” jet fuel without simple CCS is the 100% BTL jet fuel. It is 54% “greener” than the results of the JP-8 jet fuel analyzed in this thesis. The most interesting finding of the different CBTL fuel cases explored in this thesis is the “Raw Material Extraction” LCA stage of switchgrass (biomass) has a more negative effect on the environment than coal if the 50% CO<sub>2</sub>eq credit for switchgrass (biomass) is not taken (7.9 million mt CO<sub>2</sub>eq compared to 4.3 million mt CO<sub>2</sub>eq) . The reason for this finding is discussed below.

**Table 7: CBTL Different Cases Explored Without CCS**  
(Green Design Institute, Carnegie Mellon University, 2009)

	A	B	C	D	E	F
1	<b>CBTL Different Plant Configurations Without CCS Including 50% Switchgrass (Biomass) CO<sub>2</sub>eq Credit</b>					
2	Case	<u>1</u>	<u>2</u>	<u>3</u>	<u>4</u>	<u>5</u>
3	CCS (None, Simple >91%)	None	None	None	None	None
4	Switchgrass (Biomass) %	8%	15%	30%	100%	0%
5	Coal %	92%	85%	70%	0%	100%
6	Total GWP (mt CO <sub>2</sub> eq) due to Switchgrass (Biomass) ("Raw Material Extraction" LCA Stage)--EIO-LCA Results	635,609	1,192,443	2,386,421	7,952,986	0
7	Total GWP (mt CO <sub>2</sub> eq) due to Switchgrass (Biomass) ("Raw Material Extraction" LCA Stage)--EIO-LCA Results (50% CO <sub>2</sub> eq Credit)	317,804	596,221	1,193,211	3,976,493	0
8	Total GWP (mt CO <sub>2</sub> eq) due to Coal ("Raw Material Extraction" LCA Stage)--EIO-LCA Results	3,972,162	3,669,972	3,021,902	0	4,314,402
9	Total GWP (mt CO <sub>2</sub> eq)--EIO-LCA Results	4,289,967	4,266,193	4,215,112	3,976,493	4,314,402
10	Conversion to (kg CO <sub>2</sub> eq/mmBtu, LHV) (Total EIO-LCA Results*1000)/(0.124524*2.4B gals)	14.4	14.3	14.1	13.3	14.4
11	Total GWP (kg CO <sub>2</sub> eq/mmBtu, LHV) due to FT Synthesis ("Raw Material Manufacturing" LCA Stage) <small>**6% of WTW total for CBTL plants analyzed in DOE NETL's 2009 report</small>	8.5	7.1	3.9	-0.5	14.1
12	Total GWP (kg CO <sub>2</sub> eq/mmBtu, LHV)	22.8	21.3	18.0	12.8	28.5
13	% Change from JP-8 Total GWP of 27.80 kg CO <sub>2</sub> eq/mmBtu, LHV (+ = "Better"; - = "Worse")	<u>18%</u>	<u>23%</u>	<u>35%</u>	<u>54%</u>	<u>-3%</u>



When analyzing switchgrass (biomass) extraction using the EIO-LCA methodology a large amount of N<sub>2</sub>O results from farming and harvesting switchgrass as seen in Table 8. According to the 100 year potential, N<sub>2</sub>O is approximately 310 times worse for the environment when it is converted to CO<sub>2</sub> equivalency to express GWP. The reason coal outperforms switchgrass (biomass) is the total GWP is mainly due to large amounts of the GHG of CH<sub>4</sub>, which is shown in Table 9. According to the 100 year potential, CH<sub>4</sub> is approximately 21 times worse for the environment when it is converted to CO<sub>2</sub> equivalency to express GWP. This is extremely lower than N<sub>2</sub>O, which is the main reason switchgrass (biomass) has a greater GWP than does coal when converting to liquid jet fuel. Table 2 in Chapter II showed the 100 year potentials of the common GHGs. Using the EIO-LCA methodology switchgrass (biomass) planting and harvesting is worse than coal mining in terms of GWP due to the GHGs emitted during the “Raw Material Extraction” LCA stage for CBTL fuel. However, after taking the 50% CO<sub>2</sub>eq credit for the use of switchgrass (biomass) due to its potential to naturally sequester carbon both coal and switchgrass (biomass) have essentially the same effect on the environment in terms of total GWP due to the GHGs emitted during the “Raw Material Extraction” LCA stage for CBTL fuel.

**Table 8: 8% Switchgrass Analysis Sorted by N<sub>2</sub>O “Top10” Contributing Sectors**  
(Green Design Institute, Carnegie Mellon University, 2009)

	A	B	C	D	E	F	G	H	I
1			<b>Percentage of Switchgrass = 8%</b>						
2			# of Gallons Jet Fuel	192,000,000					
3			TOTAL (mt CO <sub>2</sub> eq)	635,608.5317	257,941.0919	25,925.8495	25,798.3198	324,840.6291	1,101.0201
4			TOTAL (kg CO <sub>2</sub> eq/mm Btu, LHV)	26.5849	10.7886	1.0844	1.0790	13.5868	0.0461
5	#	NAISC Code	Sector	GWP mt CO <sub>2</sub> eq	CO <sub>2</sub> Fossil mt CO <sub>2</sub> eq	CO <sub>2</sub> Process mt CO <sub>2</sub> eq	CH <sub>4</sub> mt CO <sub>2</sub> eq	N <sub>2</sub> O mt CO <sub>2</sub> eq	HFC/PFCs mt CO <sub>2</sub> eq
6									
7	1	1111A0	All other crop farming	328,019.9803	64,180.8463	0.0000	0.0000	263,837.6541	0.0000
8	2	111335	Grain farming	44,059.1627	5,879.8282	0.0000	3,255.3543	34,923.9031	0.0000
9	3	111200	Fertilizer Manufacturing	54,514.0569	12,771.3315	22,647.6255	0.0000	19,095.0999	0.0000
10	4	111920	Cattle ranching and farming	5,985.0515	349.0347	0.0000	2,759.2846	2,876.7285	0.0000
11	5	115000	Oilseed farming	1,517.6561	292.1972	0.0000	9.0556	1,216.4058	0.0000
12	6	1119B0	Animal production, except cattle and poultry and eggs	3,352.6925	409.9769	0.0000	1,920.0285	1,022.6870	0.0000
13	7	114100	Water, sewage and other systems	1,724.0402	64.6574	0.0000	1,148.2954	511.0894	0.0000
14	8	221300	Cotton farming	567.2234	128.5217	0.0000	0.0000	438.7017	0.0000
15	9	112120	Other basic organic chemical manufacturing	2,888.7037	2,538.8417	0.0000	0.0000	349.8652	0.0000
16	10	31122A	Tobacco farming	177.7885	58.4533	0.0000	0.0000	119.3350	0.0000

**Table 9: 92% Coal Analysis Sorted by CH<sub>4</sub> “Top 10” Contributing Sectors**  
(Green Design Institute, Carnegie Mellon University, 2009)

	A	B	C	D	E	F	G	H	I
1			<b>Coal Percentage = 92%</b>						
2			# of Gallons Jet Fuel	2,208,000,000					
3			TOTAL (mt CO <sub>2</sub> eq)	3,972,162.2771	938,788.0468	28,032.7543	2,992,862.3346	9,519.9865	2,960.0945
4			TOTAL (mt CO <sub>2</sub> eq) with CCS	2,140,995.4673	506,006.7572	15,109.6546	1,613,152.7983	6,131.2727	1,595.4909
5			TOTAL (kg CO <sub>2</sub> eq/mm Btu, LHV) with CCS	7.7869	1.8404	0.0550	5.8671	0.0187	0.0058
6	#	NAISC Code	Sector	GWP mt CO <sub>2</sub> eq	CO <sub>2</sub> Fossil mt CO <sub>2</sub> eq	CO <sub>2</sub> Process mt CO <sub>2</sub> eq	CH <sub>4</sub> mt CO <sub>2</sub> eq	N <sub>2</sub> O mt CO <sub>2</sub> eq	HFC/PFCs mt CO <sub>2</sub> eq
7									
8	1	212100	Coal mining	3,420,978.8531	456,878.6104	0.0000	2,964,101.4050	0.0000	0.0000
9	2	211000	Oil and gas extraction	21,789.4466	9,191.0478	1,299.8321	11,298.5376	0.0000	0.0000
10	3	486000	Pipeline transportation	11,005.2051	5,070.8587	13.8977	5,920.4212	0.0000	0.0000
11	4	562000	Waste management and remediation services	5,674.6533	267.1768	0.0000	5,407.4686	0.0000	0.0000
12	5	221200	Natural gas distribution	5,167.4312	539.7470	0.0000	4,627.6931	0.0000	0.0000
13	6	331110	Iron and steel mills	36,233.6367	17,075.8064	18,813.3136	344.5666	0.0000	0.0000
14	7	1121A0	Cattle ranching and farming	735.3926	42.8864	0.0000	339.0376	353.4681	0.0000
15	8	221300	Water, sewage and other systems	287.8622	10.7958	0.0000	191.7303	85.3363	0.0000
16	9	112A00	Animal production, except cattle and poultry and eggs	299.7541	36.6548	0.0000	171.6639	91.4354	0.0000
17	10	112120	Milk Production	157.5207	12.2115	0.0000	119.0809	26.2281	0.0000

**CBTL Plant Configurations Explored with CCS (50% CO<sub>2</sub>eq credit for switchgrass)**

Table 10 shows the results using the EIO-LCA methodology and the U.S. 2002 Benchmark model available at the EIO-LCA website of several different CBTL plant configurations with simple CCS (>91% captured). The >91% CO<sub>2</sub> captured is 91% of

the total CO<sub>2</sub> produced by the Fischer Tropsch CBTL jet fuel plant. Figure 32 is a diagram of a 15% by weight switchgrass (biomass) CBTL plant extracted from the DOE NETL's 2009 report. The figure shows that only 46.1% of the carbon entering the plant is captured by the simple CCS method. The equation below shows the calculation for the 46.1%; 13,474 and 7,267 are the tons of carbon entering the plant and the tons of carbon being captured by the simple CCS process during jet fuel production.

$$\left( (13,474 - 7,267) \div 13,474 \right) \times 100 = 46.1\%$$

**Table 10: CBTL Different Cases Explored, With Simple Carbon Capture (>91%)**

(Green Design Institute, Carnegie Mellon University, 2009)

	A	B	C	D	E	F
1	<b>CBTL Different Plant Configurations With CCS Including 50% Switchgrass (Biomass) CO<sub>2</sub>eq Credit</b>					
2	<b>Case</b>	<b>6</b>	<b>7</b>	<b>8</b>	<b>9</b>	<b>10</b>
3	CCS (None, Simple >91%)	Simple	Simple	Simple	Simple	Simple
4	Switchgrass (Biomass) %	8%	15%	30%	100%	0%
5	Coal %	92%	85%	70%	0%	100%
6	Total GWP (mt CO <sub>2</sub> eq) due to Switchgrass (Biomass) ("Raw Material Extraction" LCA Stage)--EIO-LCA Results	635,609	1,192,443	2,386,421	7,952,986	0
7	Total GWP (mt CO <sub>2</sub> eq) due to Switchgrass (Biomass) ("Raw Material Extraction" LCA Stage)--EIO-LCA Results (50% CO <sub>2</sub> eq Credit)	317,804	596,221	1,193,211	3,976,493	0
8	Total GWP (mt CO <sub>2</sub> eq) due to Coal ("Raw Material Extraction" LCA Stage)--EIO-LCA Results	3,972,162	3,669,972	3,021,902	0	4,314,402
9	Total GWP (mt CO <sub>2</sub> eq)--EIO-LCA Results	4,289,967	4,266,193	4,215,112	3,976,493	4,314,402
10	Total GWP (mt CO <sub>2</sub> eq)--EIO-LCA Results (With CCS)	2,312,292	2,299,478	2,271,945	2,143,330	2,325,463
11	Conversion to (kg CO <sub>2</sub> eq/mmBtu, LHV) (Total EIO-LCA Results*1000)/(0.124524*2.4B gals)	7.7	7.7	7.6	7.2	7.8
12	Total GWP (kg CO <sub>2</sub> eq/mmBtu, LHV) due to FT Synthesis ("Raw Material Manufacturing" LCA Stage) <i>**6% of WTW total for CBTL plants analyzed in DOE NETL's 2009</i>	4.6	3.8	2.1	-0.5	5.4
13	Total GWP (kg CO <sub>2</sub> eq/mmBtu, LHV)	12.3	11.5	9.7	6.6	13.2
14	% Change from JP-8 Total GWP of 27.80 kg CO <sub>2</sub> eq/mmBtu, LHV (+ = "Better"; - = "Worse")	56%	59%	65%	76%	53%
15	% Change from EISA 2007 GWP of 15.10 kg CO <sub>2</sub> eq/mmBtu, LHV (+ = "Better"; - = "Worse")	19%	24%	36%	56%	13%

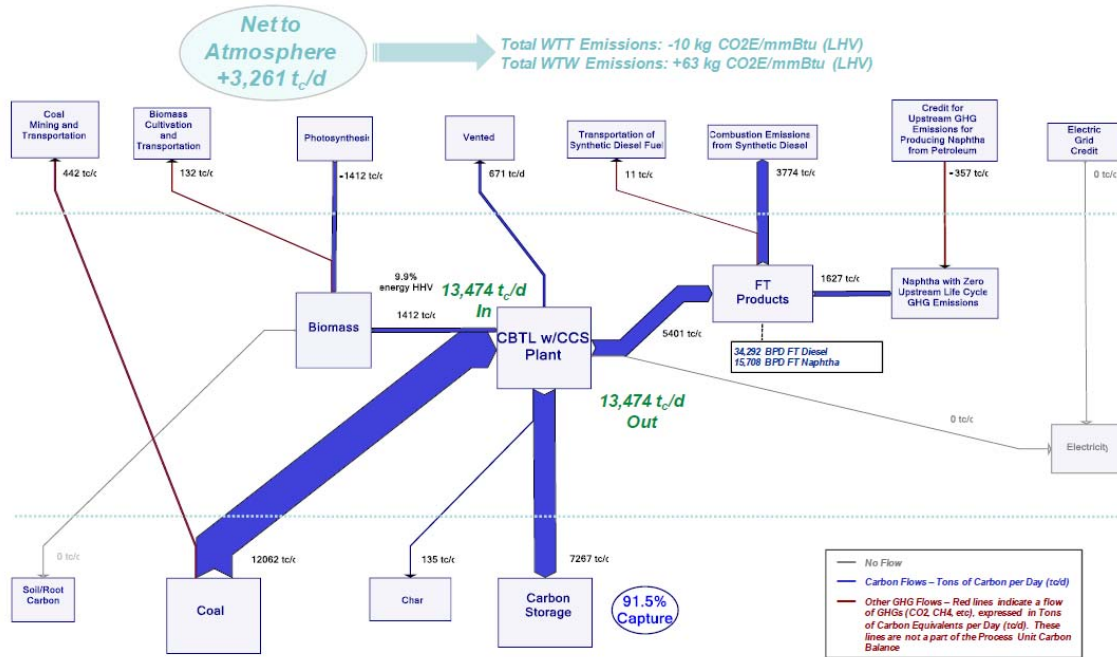

**Figure 32: Carbon Flows for 15% Switchgrass (Biomass) by Weight CBTL Plant**

(Note: Carbon Storage Approximately 46.1% of the Total Carbon Entering Plant)

(National Energy Technology Laboratory, 2009)

The 46.1% was subtracted from the total GWP of the no CCS cases presented above to explore CBTL plant configurations with simple CCS. Also, 50% CO<sub>2</sub>eq credit was taken for the use of switchgrass (biomass) due to its potential to naturally sequester carbon. When taking into account simple CCS, all three CBTL plant configurations of 8%, 15%, and 30% switchgrass (biomass) by weight are “greener” than the petroleum derived JP-8 jet fuel’s results presented above. The 100% BTL jet fuel and the 100% CTL jet fuel is 76% and 53% “greener” than the JP-8 jet fuel.

The EISA 2007 standard stating any new renewable fuel must be 20% better for the environment in terms of GWP due to the GHGs emitted compared to the petroleum derived fuels’ baselines as published in the DOE NETL’s 2008 report is met by Cases 7,

8, and 9. Again, the established “WTT” kerosene-based jet fuel GWP is 15.10 kg CO<sub>2</sub>eq/mmBtu, LHV. Compared to the GWP due to the GHGs emitted during the entire life cycle of the JP-8 jet fuel analyzed in this thesis the three cases of CBTL jet fuels, the 100% CTL jet fuel, 100% biomass- BTL jet fuel with CCS are all “greener” for the environment. In the without CCS plant configuration the only jet fuel not “greener” than the JP-8 jet is the 100% CTL jet fuel. It is 3% worse for the environment than JP-8 petroleum derived jet fuel without carbon capture.

## Chapter V: Conclusion

### Overview

This chapter summarizes the results from this study and provides the significant conclusion and hypothesis. The research objective is reviewed and the conclusion and insight gained from the objective is shared. The limitations and assumptions made in this thesis are discussed. This chapter also reviews the significance of this research and the contribution it made to the literature in this area. The chapter ends with suggestions and insights for future research.

### Research Objective Conclusion

The current USAF energy policy, AFEPPM 10-1.1 (16 June 2009), states the AF must be prepared to acquire 50% of its domestic aviation fuel requirement by FY 2016 via an alternative fuel blend in which the alternative fuel component is derived from domestic sources that are “greener” than fuels produced from conventional petroleum (Donley, 2009). The purpose and objective of this thesis was to compare the alternatively produced jet fuel of CBTL to the petroleum derived jet fuel of JP-8 performing a LCA of both of the fuels using the EIO-LCA methodology to determine which jet fuel is “greener” (lower total GWP due to GHGs emitted during the entire life cycle of each jet fuel) for the environment.

Table 11 summarized the most “green” to least “green” jet fuel analyzed in this thesis. Based on the results presented in Chapter IV, the total GWP based on the amount of GHGs it emits over its life cycle of the JP-8 jet fuel analyzed in this thesis is approximately 27.80 kg CO<sub>2</sub>eq/mmBtu LHV. The total GWP of all the CBTL cases with



and without simple CCS are less than the total for the JP-8 jet fuel except the 100% CTL jet fuel without CCS. Based on the EIO-LCA methodology and the assumptions made completing the work of this thesis, CBTL is a “greener” jet fuel for all cases when the plant is configured without or with simple CCS compared to JP-8 jet fuel for the total “WTT” GWP due to the GHGs emitted over each jet fuel’s entire life cycle.

**Table 11: CBTL Plant Configurations, Ranked Most “Green” to Least “Green” Jet Fuel**

(Green Design Institute, Carnegie Mellon University, 2009)

<b>CBTL Plant Configurations</b> <b>Ranked Most "Green" to Least "Green" Jet Fuel</b> <b>(+ = "Better"; - = "Worse")</b>								
Rank	Case	Biomass %	Coal %	CCS (None, Simple >91%)	Total GWP "WTT" (kg CO <sub>2</sub> eq/mmBtu, LHV)	% Change from JP-8 Total GWP of 27.80 kg CO <sub>2</sub> eq/mmBtu, LHV	% Change from Kerosene- Based Jet Fuel Baseline Total GWP of 15.10 kg CO <sub>2</sub> eq/mmBtu, LHV	
1	9	100%	0%	Simple	6.6	76%	56%	
2	8	30%	70%	Simple	9.7	65%	36%	
3	7	15%	85%	Simple	11.5	59%	24%	
4	6	8%	92%	Simple	12.3	56%	19%	
5	4	100%	0%	None	12.8	54%	15%	
6	10	0%	100%	Simple	13.2	53%	13%	
7	3	30%	70%	None	18.0	35%	-19%	
8	2	15%	85%	None	21.3	23%	-41%	
9	1	8%	92%	None	22.8	18%	-51%	
10	5	0%	100%	None	28.5	-3%	-89%	

### Limitations and Assumptions

This research focused on comparing the petroleum derived jet fuel of JP-8 to the alternatively derived from coal and biomass jet fuel of CBTL to determine which is “greener” for the environment by analyzing the GHGs emitted during each jet fuel’s entire life cycle. The EIO-LCA methodology was used to obtain the total GWP due to

the GHGs emitted during each LCA stage for each jet fuel as a basis of comparison. The total GWP for each life cycle assessment stage was then summed; the jet fuel with the lowest GWP was determined to be the “greener” jet fuel for the environment. The limitations and uncertainty of the EIO-LCA methodology were discussed in Chapter II. The results from this thesis are not exact and several assumptions were made to develop the final comparison.

First, the percentage of the costs input into the EIO-LCA on-line tool for JP-8 was correlated to diesel fuel. Typically, crude oil extraction accounts for approximately 65-70% and refining accounts for approximately 5-15% of the final cost of diesel fuel and jet fuel. The current percentages, according to the U.S. EIA for diesel fuel sold in the U.S., was used to determine the “Raw Material Extraction” LCA stage cost and the “Raw Material Manufacturing” LCA stage cost for JP-8 jet fuel. The percentages used in this thesis were 65% for crude oil extraction and 6% for crude oil refining for the JP-8 jet fuel analyzed. Kerosene-based jet fuel, such as JP-8, is distilled to approximately the same temperature as distillate diesel fuel. The assumption was made because exact figures of the percentages of the final cost of typical JP-8 or other kerosene-based jet fuel could not be found for both crude oil extraction and refining costs.

Next, the “Jet Fuel Use” LCA stage was assumed to be exactly the same for both JP-8 jet fuel and CBTL jet fuel. In order for any renewable jet fuel to be used by the USAF it must meet strict specifications to ensure flight safety of current aircraft. The “Jet Fuel Use” LCA stage typically accounts for 84% of the total “well-to-wheels/wake (WTW)” GWP due to the GHGs emitted during this LCA stage (National Energy



Technical Laboratory, 2008). Because of this assumption, the comparison of JP-8 to CBTL jet fuel in this thesis was a “well-to tank (WTT)” LCA of the two fuels.

Finally, the EIO-LCA methodology uncertainty and limitations were discussed in Chapter II. The U.S. 2002 Benchmark model was used as the tool to determine the total GWP due to the GHGs emitted during the “WTT” LCA of both of the fuels. The data in the 2002 model is now over seven years old and dependent on the accuracy of the U.S. BEA surveys and the resulting economic input-out tables completed by the industries prior to 2002. The EIO-LCA methodology’s results are not exact, but a decent approximation to determine which jet fuel is “greener” by using this methodology can be assumed.

### **Significance of Research**

This research demonstrated one method of comparing an alternatively produced jet fuel to a petroleum derived jet fuel to determine which jet fuel is “greener” for the environment by determining which jet fuel has a lower total GWP due to the GHGs emitted over its entire life cycle. Again, USAF decision makers must consider fuels that are cost-comparable, sustainable, capable of being produced in significant quantities, have a lifecycle GHG footprint lower than petroleum derived jet-fuel (“greener”), and produce no degradation of flight safety (Edwards, 2009). The purpose of this thesis was to compare the alternatively produced jet fuel, CBTL to the current petroleum derived jet fuel of JP-8 to determine which jet fuel is “greener” for the environment. The environmental impact of the jet fuel is only one of the five criteria the USAF defined to

determine if an alternatively produced jet fuel should be considered for use as a 100% drop-in replacement of JP-8 jet fuel or to be used as a 50/50 jet fuel blendstock.

However, because of the 2007 EISA standard it is now one of the most important criteria when analyzing an alternative jet fuel. No government agency, including the USAF, can even consider any renewable fuel unless it has a total GWP due to the GHGs emitted during its entire life cycle that is 20% less than the 2005 baseline set forth in the DOE NETL's 2008 report establishing the baseline. Again, the "WTW" baseline is 92.9 kg CO<sub>2</sub>eq/mmBtu, LHV and the "WTT" baseline is 15.1 kg CO<sub>2</sub>eq/mmBtu, LHV for kerosene-based jet fuel. The 2007 EISA standard has made it very difficult for any government department to pursue renewable and alternative fuel sources.

The total "WTT" GWP due to the GHGs emitted during the entire life cycle of the JP-8 (petroleum derived) jet fuel analyzed in this thesis of approximately 27.80 kg CO<sub>2</sub>eq/mmBtu, LHV is significant because the result falls in the middle of the spectrum of previous LCA conducted on diesel fuel. As you can see from Figure 33 previous LCA studies of a "WTT" analysis of diesel fuels had similar results of the results in this thesis. Again, diesel fuel is similar to kerosene-based jet fuel because it is distilled at essentially the same temperature on the distillation tower. Figure 33 shows the EIO-LCA analysis of the JP-8 jet fuel in this thesis and the resulting "WTT" GWP figure of 27.80 kg CO<sub>2</sub>eq/mmBtu, LHV is correct because it falls within the range of previous studies.

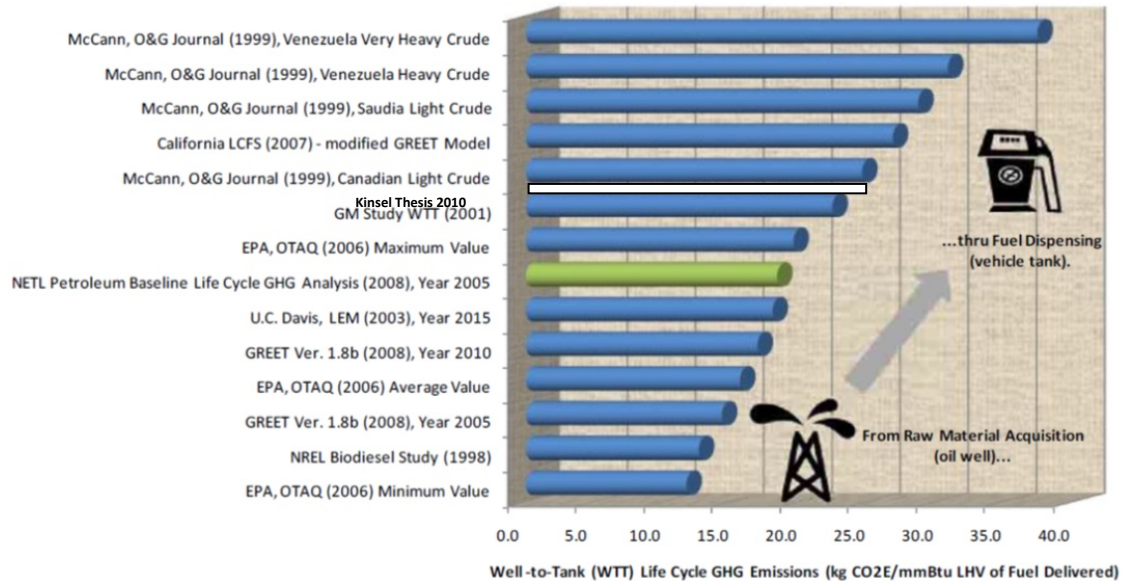

**Figure 33: Comparison of Diesel Fuel Greenhouse Gas Profiles from Various "WTT" LCA Studies**

(National Energy Technology Laboratory, 2009)

### Future Research

Of the five criteria the USAF set forth to determine if an alternative jet fuel should be considered for use as a 100% drop-in replacement or jet fuel blendstock of JP-8 jet fuel, the sustainability criterion is the most ambiguous. According to the National Biofuels Action Plan, “A key goal of the National Biofuels Action Plan is to maximize the environmental and economic benefits of biofuels use by advancing sustainable practices and improvements in efficiency throughout the biofuels supply chain from feedstock production to final use” (Biomass Research and Development Board, 2008). “Sustainable” as defined by E.O. 13423 is to “create and maintain conditions under which human and nature can exist in productive harmony, that permits fulfilling the social, economic, and other requirements of present and future generations of Americans”

(President George W. Bush, 2007). Sustainability is “fuzzy” and very difficult to define in definite scientific terms and metrics. Future research could address what the exact USAF values are for an alternative fuel to be considered “sustainable”.

The cost criterion also needs to be explored in more depth. The required selling price (RSP) of the various configurations of diesel produced from switchgrass (biomass), coal, and a combination of the two is shown in Table 12. These costs are the calculated costs for the various CBTL diesel fuel plant configurations analyzed in the DOE NETL’s 2009 report on affordable low carbon diesel fuel produced from domestic coal and biomass. It can be assumed that similar RSPs would exist for selling the various cases of CBTL jet fuel analyzed in this thesis. Again, world crude oil price/bbl must exceed the costs for the various CBTL plant configurations shown in Table 12 for alternative fuels to become economically feasible.

**Table 12: RSP, Crude Oil Barrel Equivalence of Various CBTL Diesel Fuel Plant Configurations**

(National Energy Technology Laboratory, 2009)

CO <sub>2</sub> charges	CTL w/o CCS	CTL+CCS	CTL+CCS+ ATR	8wt% CBTL+CCS	15wt% CBTL+CCS	BTL w/o CCS	BTL+CCS+ ATR
CO <sub>2</sub> = \$0/t	\$84.50	\$86.58	\$92.52	\$93.09	\$95.44	\$218.43	\$234.94
CO <sub>2</sub> = \$45/t	\$100.09	\$80.98	\$85.97	\$85.41	\$85.95	\$198.29	\$180.11
CO <sub>2</sub> = \$90/t	\$115.69	\$75.37	\$79.43	\$77.74	\$76.43	\$178.14	\$125.27

Additionally, future research should expand on the results that various configurations of CBTL jet fuel, 100% BTL, and 100% CTL jet fuel are “greener” for the environment compared to the petroleum derived JP-8 jet fuel analyzed in this thesis

without CCS and with simple CCS as part of the process. Coal is an abundant natural resource in the U.S. According to the EIA website, “Based on U.S. coal consumption for 2008, the U.S. recoverable coal reserves represent enough coal to last 234 years. However, EIA projects in the most recent Annual Energy Outlook (April 2009) that U.S. coal consumption will increase at about 0.6% per year for the period 2007-2030. If that growth rate continues into the future, U.S. recoverable coal reserves would be exhausted in about 146 years if no new reserves are added.

The alternative jet fuels analyzed in this thesis are better for the environment without simple carbon capture and storage (CCS) methods, but even better for the environment with simple CCS methods. CCS is a new technology and many scientists and government officials are skeptical about this technology. According to the DOE NETL’s 2009 report on CBTL fuel,

“In cases enabled for CCS, CO<sub>2</sub> captured in the plant is dried and compressed for pipeline transport to 2,200 pounds per square inch absolute (psia), at which point it is a supercritical fluid. A pipeline length of 50 miles is assumed and the pipeline diameter is specified such that the CO<sub>2</sub> pressure is 1,200 psia at the pipeline destination, providing a 10% safety margin above the critical-point. This design removes the need for recompression stages. Transported CO<sub>2</sub> is injected into a saline formation for long-term storage with provisions for 80 years of monitoring to ensure the CO<sub>2</sub> remains in place. The costs associated with each CCS stage – compression through monitoring – are included in both the selling price of the fuel and the capital and operating costs reported throughout this document. These costs represent approximately 4% of the overall capital costs,

and therefore do not have a dramatic effect on the RSP of the final diesel fuel product” (National Energy Technology Laboratory, 2009).

Both the feasibility of the simple CCS technology explained in the 2009 NETL report and their claim that CCS only adds 4% to the overall capital costs of a CBTL fuel must be researched in more detail.

Our country’s national security and future of our nation depends on ways to lessen the amount of crude oil and petroleum products we import, which is currently 57% and climbing” (Energy Information Administration (f), 2010). The demand for our nation’s thirst for energy and energy sources will continue to grow. 100% biomass-to-liquid (BTL), 100% coal-to-liquid (CTL) and various configurations of coal-biomass-to-liquid (CBTL) fuels and jet fuels should be explored in more detail by both the U.S. and the USAF. These fuels may be the jet fuels to meet the USAF’s 2016 goal.

## Appendix A: Detailed Mathematical Calculations for EIO-LCA Methodology

The entire appendix is copied from <http://www.eiolca.net/Method/eiolca%20math.pdf>

(Green Design Institute, Carnegie Mellon University, 2009)

Combining life cycle assessment and economic input-output is based on the work of Wassily Leontief in the 1930s. Leontief developed the idea of input-output models of the U.S. economy and theorized about expanding them with non-economic data. But the computational power at the time limited uses of the Economic Input-Output method that required matrix algebra.

From the Input-Output accounts a matrix or table **A** is created that represents the direct requirements of the intersectoral relationships. The rows of **A** indicate the amount of output from industry *i* required to produce one dollar of output from industry *j*. These are considered the direct requirements – the output from first tier of suppliers directly to the industry of interest.

Next, consider a vector of final demand, **y**, of goods in the economy. The sector in consideration must produce **I**×**y** units of output to meet this demand. At the same time **A**×**y** units of output are produced in all other sectors. So, the result is more than demand for the initial sector, but also demand for its direct supplier sectors. The resulting total output, **x<sub>direct</sub>**, of the entire economy can be written

$$\mathbf{x}_{\text{direct}} = (\mathbf{I} + \mathbf{A})\mathbf{y}$$

This relationship takes into account only one level of suppliers, however. The demand of output from the first-tier of suppliers creates a demand for output from *their* direct suppliers (i.e., the second-tier suppliers of the sector in consideration). For example, the demand for computers from the computer manufacturing sector results in a demand for semiconductors from the semiconductor manufacturing sector (first-tier). That in turn results in a demand from the electricity generation sector (second-tier) to operate the semiconductor manufacturing facilities. This demand continues throughout the economy. The output demanded from these second-tier sectors and beyond is considered indirect output.

The second-tier supplier requirements are calculated by further multiplication of the direct requirements matrix by the final demand, or **A**×**A**×**y**. In many cases, third and fourth or more tiers of suppliers exist, resulting in a summation of many of these factors so that the total output can be calculated as:

$$\mathbf{X} = (\mathbf{I} + \mathbf{A} + \mathbf{AA} + \mathbf{AAA} + \dots)\mathbf{y}$$

where  $\mathbf{X}$  (with no subscript) is a vector including all supplier outputs, direct and indirect.

The expression  $(\mathbf{I} + \mathbf{A} + \mathbf{AA} + \mathbf{AAA} + \dots)$  can be shown to be equivalent to  $(\mathbf{I}-\mathbf{A})^{-1}$ , which is called the total requirements matrix or the Leontief inverse. The relationship between final demand and total output can be expressed compactly as:

$$\mathbf{X} = (\mathbf{I}-\mathbf{A})^{-1}\mathbf{y} \text{ or } \Delta \mathbf{X} = (\mathbf{I}-\mathbf{A})^{-1}\Delta\mathbf{y}$$

where the latter expression indicates that the EIO framework can be used to determine relative changes in total output based on an incremental change in final demand. Typically, the values in the matrices and vectors are expressed in dollar figures (i.e., in the direct requirements matrix,  $\mathbf{A}$ , the dollar value of output from industry  $i$  used to produce one dollar of output from industry  $j$ ). This puts all items in the economy, petroleum or coal or electricity, into comparable units.

The economic input-output analysis can then be augmented with additional, noneconomic data. One can determine the total external outputs associated with each dollar of economic output by adding external information to the EIO framework. First, the total external output per dollar of output is calculated from:

$$R_i = \text{total external output} / X_i$$

where  $R_i$  is used to denote the impact in sector  $i$ , and  $X_i$  is the total dollar output for sector  $i$ .

To determine the total (direct plus indirect) impact throughout the economy, the direct impact value is used with the EIO model. A vector of the total external outputs,  $\mathbf{B}_i$ , can be obtained by multiplying the total economic output at each stage by the impact:

$$\Delta \mathbf{b}_i = \mathbf{R}_i \Delta \mathbf{X} = \mathbf{R}_i (\mathbf{I}-\mathbf{A})^{-1} \Delta \mathbf{y}$$

where  $\mathbf{R}_i$  is a matrix with the elements of the vector  $R_i$  along the diagonal and zeros elsewhere, and  $\mathbf{X}$  is the vector of relative change in total output based on an incremental change in final demand. A variety of impacts can be included in the calculation – resource inputs such as



## Bibliography

Aimone, M. A. (2009). Eliminating Energy Waste...The Role you Can (and Should) Play. *Society of American Engineers Conference* (p. 41). Salt Lake: Society of American Engineers.

Air Transport Action Group. (2009). *Beginner's Guide to Aviation Biofuels*. Geneva: Air Transport Action Group.

American Coal Foundation. (2007, January 01). *All About Coal*. Retrieved December 22, 2009, from Teach Coal: <http://www.teachcoal.org/aboutus.html>

American Petroleum Institute. (2009, January 01). *Adventures in Energy*. Retrieved December 16, 2009, from American Petroleum Institute: <http://www.adventuresinenergy.org/index.html>

Andrews, A. (2009). *Department of Defense Fuel Spending, Supply, Acquisition, and Policy*. Washington D.C.: Congress Research Service.

Biomass Research and Development Board. (2008). *National Biomass Action Plan*. Washington D.C.: United States Government.

Blade Energy Crops. (2009). *Planting and Managing Switchgrass as a Dedicated Energy Crop*. College Station: Ceres Incorporated.

Boland, R. (2007). Services Transition to New Energy Sources. *SIGNAL Magazine* , 1-4.

Carnegie Mellon University Green Design Institute. (2008, January 01). *EIO-LCA*. Retrieved August 10, 2009, from Carnegie Mellon University: <http://www.eiolca.net>

Chris DiPetto, OSD/AT&L. (2008). *Department of Defense Energy Security Task Force Update*. Washington D. C.: OSD.

Congress of the United States, Office of Technology Assessment. (1992). *Green Products by Design: Choices for a Cleaner Environment*. Washington D.C.: Office of Technology Assessment.

Conway-Schempf, N. (2007). *Case Study: Economic Input-Output Life Cycle Assessment of Asphalt versus Steel Reinforced Concrete for Pavement Construction*. Pittsburgh: Carnegie Mellon University.

Department of Defense. (1991). *DoDI 4170.10, Energy Management Policy*. Washington D.C.: United States Government.

Department of Defense. (2005). *Department of Defense Instruction 4170.11, Installation Energy Management*. Washington D.C.: United States Government.

DiPetto, C. (2008). *Department of Defense Energy Security Task Force Update*. Washington D. C.: OSD/AT&L Pentagon.

Donley, M. B. (2009). *Air Force Energy Program Policy Memorandum, 10-1.1*. Washington D.C.: United States Air Force.

Ducote, N., & Burnett, S. H. (2009). *Turning Coal into Liquid Fuel*. Washington D.C.: National Center for Policy Analysis.

Edwards, T. (2009). *Biomass-Derived Aviation Fuels*. Wright Patterson AFB: Air Force Research Laboratories.

Energy Information Administration (a). (2008, January 01). *Oil: Crude and Petroleum Products Explained*. Retrieved December 16, 2009, from Energy Information Administration: [http://tonto.eia.doe.gov/energyexplained/index.cfm?page=oil\\_home#tab1](http://tonto.eia.doe.gov/energyexplained/index.cfm?page=oil_home#tab1)

Energy Information Administration (b). (2009, June 09). *Short Term Energy Outlook*. Retrieved June 15, 2009, from Energy Information Administration (EIA), Official Energy Statistics of the US Government: <http://www.eia.doe.gov/steo>

Energy Information Administration (c). (2008, January 01). *EIA Kids Page*. Retrieved June 18, 2009, from EIA.doe.gov: <http://www.eia.doe.gov/kids/history/timelines/petroleum.html>

Energy Information Administration (d). (2009). *Greenhouse Gases, Climate Change & Energy*. Washington D.C.: EIA.DOE.gov.

Energy Information Administration (e). (2009, November 01). *Diesel Fuel Explained: Diesel Fuel Outlook*. Retrieved January 2010, 2010, from Energy Information Administration: [http://tonto.eia.doe.gov/energyexplained/index.cfm?page=diesel\\_prices](http://tonto.eia.doe.gov/energyexplained/index.cfm?page=diesel_prices)

Energy Information Administration (f). (2010, January 11). *Coal News and Markets*. Retrieved January 18, 2010, from Energy Information Administration: <http://www.eia.doe.gov/cneaf/coal/page/coalnews/coalmar.html#spot>

Environmental Protection Agency. (2007). *The Plain English Guide to the Clean Air Act*. Research Triangle Park: Office of Air Quality and Standards.

Environmental Protection Agency. (2010, January 01). *Emission Facts: Metrics for Expressing Greenhouse Gas Emissions: Carbon Equivalents and Carbon Dioxide Equivalents* . Retrieved January 28, 2010, from EPA.gov:  
<http://www.epa.gov/otaq/climate/420f05002.htm>

Gary, J., & Handwerk, G. (1975). *Petroleum Refining: Technology and Economics*. New York: Marcel Dekker.

Green Design Institute, Carnegie Mellon University. (2008). *Approaches to Life Cycle Assessment*. Retrieved October 30, 2009, from [www.eiolca.net](http://www.eiolca.net): [www.eiolca.net](http://www.eiolca.net)

Green Design Institute, Carnegie Mellon University. (2009, January 01). *Economic Input-Output Life Cycle Assessment*. Retrieved September 17, 2009, from Carnegie Mellon University: <http://www.eiolca.net/>

Hendrickson, C. T., Horvath, A., Joshi, S., Klausner, M., Lave, L. B., & McMichael, F. C. (1997). Comparing Two Life Cycle Assessment Approaches: A Process Model vs Economic Input-Output-Based Assessment. *International Symposium on Electronics and the Environment*, (pp. 176-181). San Francisco, CA.

Hendrickson, C. T., Lave, L. B., & Matthews, H. S. (2006). *Environmental Life Cycle Assessment of Goods and Services*. Washington D.C.: Resources For The Future Press.

Hendrickson, C., Horvath, A., Joshi, S., & Lave, L. (1998). Economic Input-Output Models for Environmental Life-Cycle Assessment. *Env. Sci. & Tech. Policy Analysis* , 184-191.

Hofstrand, D. (2007). *Energy Measurements and Conversions*. Ames: Iowa State University Agriculture Marketing Resource Center.

Horvath, A. (2006, September 20). Life Cycle Costing . *Models of Life-cycle Assessment (LCA)-Part I* . University of California, Berkeley, California, United States: University of California.

Huang, A. Y., & Matthews, H. S. (2008). Seeking Opportunities to Reduce Life Cycle Impacts of Consumer Goods- An Economy-Wide Assessment. *2008 IEEE International Symposium on Electronics and the Environment*, (pp. 1-6). San Francisco, CA.

Kreutz, T. G. (2008). Fischer-Tropsch Fuels from Coal and Biomass. *25th Annual International Pittsburgh Coal Conference* (p. 86). Pittsburgh: Princeton Environmental Institute.

MIL-HDBK-510-1 (USAF). (2008). *Department of Defense Handbook: Aerospace Fuels Certification MIL-HDBK-510-1*. Washington D.C.: United States Air Force.

National Energy Technical Laboratory. (2008). *Development of Baseline Data and Analysis of Life Cycle Greenhouse Gas Emissions of Petroleum-Based Fuels*. Washington D.C.: Department of Energy.

National Energy Technology Laboratory. (2009). *Affordable Low-Carbon Diesel Fuel from Domestic Coal and Biomass*. Washington D.C.: United States Department of Energy.

National Risk Management Research Laboratory, U.S. EPA. (2006). *Life Cycle Assessment: Principles and Practice*. Reston: Scientific Applications International Corporation.

Office of Transportation and Air Quality: U.S. EPA. (2005). *Metrics for Expressing Greenhouse Gas Emissions: Carbon Equivalents and Carbon Dioxide Equivalents*. Washington D.C.: Office of Transportation and Air Quality: United States Environmental Protection Agency.

Paleontological Research Institute. (2009, June 18). *Petroleum Education*. Retrieved June 18, 2009, from Priweb.org: [http://www.priweb.org/ed/pgws/history/history\\_home.html](http://www.priweb.org/ed/pgws/history/history_home.html)

Pirog, R. (2005). *World Oil Demand and its Effect on Prices*. Washington D.C.: CRS Report for Congress.

Popp, M., & Hogan, R. J. (2009). Assessment of Two Alternative Switchgrass Harvest and Transport Methods. *Farm Foundation Conference* (p. 9). St Louis: Farm Foundation.

President George W. Bush. (2007). *E.O. 13423 Strengthening Federal Environmental, Energy, and Transportation Management*. Washington D.C.: United States Government.

Propulsion Directorate, Air Force Research Laboratory. (2009). *Biofuels for Military Aviation - An Overview*. Wright Patterson AFB: United States Air Force.

Robertson, P. G., Dale, V. H., Doering, O. C., Hamburg, S. P., Melillo, J. M., Wander, M. M., et al. (2008, October 3). Sustainable Biofuels Redux. *Science*, pp. 49-50.

Schoen, J. W. (2004, October 25). *How Long Will the World's Energy Last*. Retrieved June 12, 2009, from www.msnbc.com: <http://www.msnbc.msn.com/id/5945678/>

Scientific Application International Corporation for United States Environmental Protection Agency. (2006). *Life Cycle Assessment: Principles and Practice*. Cincinnati: National Risk Management Research Laboratory.

Searchinger, T., Heimlich, R., Houghton, R., Dong, F., Elobeid, A., Fabiosa, J., et al. (2008, February 29). Use of U.S. Croplands for Biofuels Increases Greenhouse Gases Through Emission from Land-Use Change. *Science* , pp. 1238-1240.

Shell. (2009, January 01). *The History of Fuel*. Retrieved June 24, 2009, from Shell.com: [http://www.shell.com/home/content2/id-en/shell\\_for\\_motorists/fuels/fuels\\_history\\_retail\\_0319.html](http://www.shell.com/home/content2/id-en/shell_for_motorists/fuels/fuels_history_retail_0319.html)

Sorensen, B. (2010, February 12). Carbon Calculations to Consider. *Science* , pp. 780-781.

U.S. Department of Transportation. (2002). *Effects of the Alternative Motor Fuels Act CAFE Incentives Policy*. Washington D.C.: United States Government.

U.S. Environmental Protection Agency. (2008, August 01). *Climate Change - Greenhouse Gas Emissions*. Retrieved September 15, 2009, from EPA.gov: <http://www.epa.gov/climatechange/emissions/index.html>

U.S. Environmental Protection Agency. (2005, November 22). *Diesel Fuel Sulfur Program*. Retrieved July 01, 2009, from EPA.gov: 2009

United Nations Environment Programme. (2004). *Why Take a Life Cycle Approach?* New York: St Joseph Print Group.

United States Congress. (1992). *Energy Policy Act of 1992*. Washington D.C.: United States Government.

United States Congress. (2005). *Energy Policy Act of 2005*. Washington D.C.: United States Government.

United States Congress. (2007). *Energy Independence and Security Act (EISA) 2007*. Washington D.C.: United States Government.

United States Congress. (2009). *American Recovery and Reinvestment Act (ARRA) 2009*. Washington D.C.: United States Government.

United States Department of Energy. (2009, July 10). *Alternative Fuels and Advanced Vehicles Data Center*. Retrieved September 17, 2009, from State and Federal Incentives and Laws: [http://www.afdc.energy.gov/afdc/incentives\\_laws\\_legislation.html#epact92](http://www.afdc.energy.gov/afdc/incentives_laws_legislation.html#epact92)

University of Dayton Research Institute. (2010). *Characterizing the Greenhouse Gas Footprints of Aviation Fuels from Fischer Tropsch Processing*. Dayton: University of Dayton Research Institute prepared by The University of Texas at Austin, Center for Energy and Environmental Resources.

University of Michigan. (1998). *Greenhouse Gases and Society*. Ann Arbor: University of Michigan.

## Vita

Capt Wayne C. Kinsel graduated from Martins Ferry High School in Martins Ferry, OH in 1994. In January 1995, Capt Kinsel entered active duty as an enlisted member. He graduated from Space Systems Maintenance Specialist Course in August 1995. His first duty assignment was Holloman AFB, New Mexico as a Space Systems Maintenance Apprentice. In June 1996, Capt Kinsel was selected to attend the United States Air Force Academy Preparatory School and graduated in May 1997. His performance at the Preparatory School earned him an Appointment to the United States Air Force Academy, Class of 2001.

Capt Kinsel graduated in May 2001 with a Bachelor of Science degree in Civil Engineering. His first position as an officer was Design Civil Engineer, 319<sup>th</sup> Civil Engineer Squadron, Grand Forks AFB, North Dakota. In August 2004, he transferred to Kunsan AB, South Korea, and became the Chief of Base Development, 8<sup>th</sup> Civil Engineer Squadron. In August 2005, Capt Kinsel transferred to RAF Alconbury, England, and became the Engineering Flight Chief, 423<sup>rd</sup> Civil Engineer Squadron. He deployed with the U.S. Army to Kabul, Afghanistan October 2006-April 2007. Upon returning to RAF Alconbury, Capt Kinsel became the Operations Flight Commander.

In August 2008, he entered the Graduate School of Engineering and Management, Air Force Institute of Technology, where he earned a Master's of Science degree in Engineering Management with a focus in Crisis Management. Upon graduation, he will be assigned HQ AFMC A7 Staff at Wright Patterson AFB, Ohio.

<b>REPORT DOCUMENTATION PAGE</b>			<i>Form Approved</i> OMB No. 074-0188		
<p>The public reporting burden for this collection of information is estimated to average 1 hour per response, including the time for reviewing instructions, searching existing data sources, gathering and maintaining the data needed, and completing and reviewing the collection of information. Send comments regarding this burden estimate or any other aspect of the collection of information, including suggestions for reducing this burden to Department of Defense, Washington Headquarters Services, Directorate for Information Operations and Reports (0704-0188), 1215 Jefferson Davis Highway, Suite 1204, Arlington, VA 22202-4302. Respondents should be aware that notwithstanding any other provision of law, no person shall be subject to a penalty for failing to comply with a collection of information if it does not display a currently valid OMB control number.</p> <p><b>PLEASE DO NOT RETURN YOUR FORM TO THE ABOVE ADDRESS.</b></p>					
<b>1. REPORT DATE (DD-MM-YYYY)</b> 25-03-2010		<b>2. REPORT TYPE</b> Master's Thesis		<b>3. DATES COVERED (From - To)</b> Jan 2009 - Mar 2010	
<b>4. TITLE AND SUBTITLE</b>  Environmental Life Cycle Assessment of Coal-Biomass to Liquid Jet Fuel Compared to Petroleum-Derived JP-8 Jet Fuel			<b>5a. CONTRACT NUMBER</b>		
			<b>5b. GRANT NUMBER</b>		
			<b>5c. PROGRAM ELEMENT NUMBER</b>		
<b>6. AUTHOR(S)</b>  Kinsel, Wayne C., Captain, United States Air Force			<b>5d. PROJECT NUMBER</b>		
			<b>5e. TASK NUMBER</b>		
			<b>5f. WORK UNIT NUMBER</b>		
<b>7. PERFORMING ORGANIZATION NAMES(S) AND ADDRESS(S)</b>  Air Force Institute of Technology Graduate School of Engineering and Management (AFIT/EN) 2950 Hobson Way WPAFB OH 45433-7765			<b>8. PERFORMING ORGANIZATION REPORT NUMBER</b>  AFIT/GEM/ENV/10-M05		
<b>9. SPONSORING/MONITORING AGENCY NAME(S) AND ADDRESS(ES)</b>  James T. Edwards, Civ, AFMC AFRL/RZPF 1790 Loop Rd. N. WPAFB, OH 45433-7103 DSN: 785-3524			<b>10. SPONSOR/MONITOR'S ACRONYM(S)</b>  AFMC AFRL/RZPF		
			<b>11. SPONSOR/MONITOR'S REPORT NUMBER(S)</b>		
<b>12. DISTRIBUTION/AVAILABILITY STATEMENT</b>  Unclassified Unlimited					
<b>13. SUPPLEMENTARY NOTES</b>  This material is declared a work of the U.S. Government and is not subject to copyright protection in the United States.					
<b>14. ABSTRACT</b>  The United States (U.S.) imported 57% of the petroleum products that it consumed in 2008. The Department of Defense (DOD) and in particular, the United States Air Force (USAF), consumes a large amount of oil to support the mission of defending the U.S. According to the USAF energy policy, by 2016, the Air Force (AF) must be prepared to cost competitively acquire 50% of its domestic aviation fuel requirement via an alternative fuel blend in which the alternative component is derived from domestic sources produced in a manner that is "greener" than fuels produced from conventional petroleum. This study employed a life cycle assessment (LCA) tool known as Economic Input-Output Life Cycle Assessment (EIO-LCA) to compare the petroleum derived jet fuel of JP-8 to the alternative jet fuel of Coal-Biomass to Liquid (CBTL) to determine which was "greener" by determining the total global warming potential (GWP) over each jet fuels' entire life cycle. The CBTL jet fuel was determined to be "greener" for the environment with utilizing carbon capture and storage (CCS) via the Fischer Tropsch (FT) synthesis process when producing liquid jet fuel from coal and switchgrass as the biomass.					
<b>15. SUBJECT TERMS</b> Alternative Jet Fuel, Coal-Biomass to Liquid, JP-8 Jet Fuel, USAF Energy Policy, Green, Fischer Tropsch					
<b>16. SECURITY CLASSIFICATION OF:</b>			<b>17. LIMITATION OF ABSTRACT</b>	<b>18. NUMBER OF PAGES</b>	<b>19a. NAME OF RESPONSIBLE PERSON</b>
a. REPORT	b. ABSTRACT	c. THIS PAGE	UU	135	Dr. Charles A. Bleckmann, AFIT/ENV
U	U	U			<b>19b. TELEPHONE NUMBER (Include area code)</b> 785-3636 x4721
<b>Standard Form 298 (Rev. 8-98)</b> Prescribed by ANSI Std. Z39-18					
			<i>Form Approved</i> OMB No. 074-0188		